

EURO ALU - PROFIL SOFT - FENSTER.

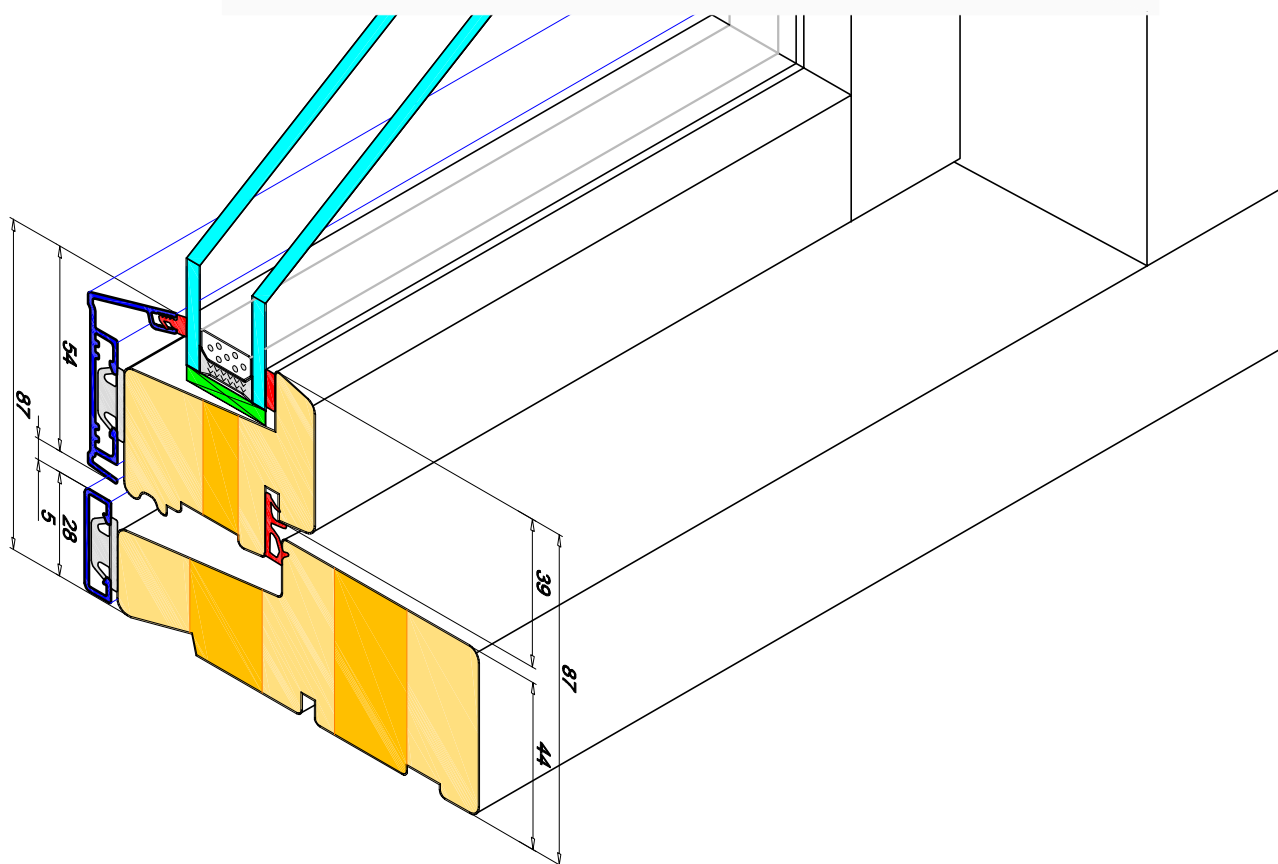

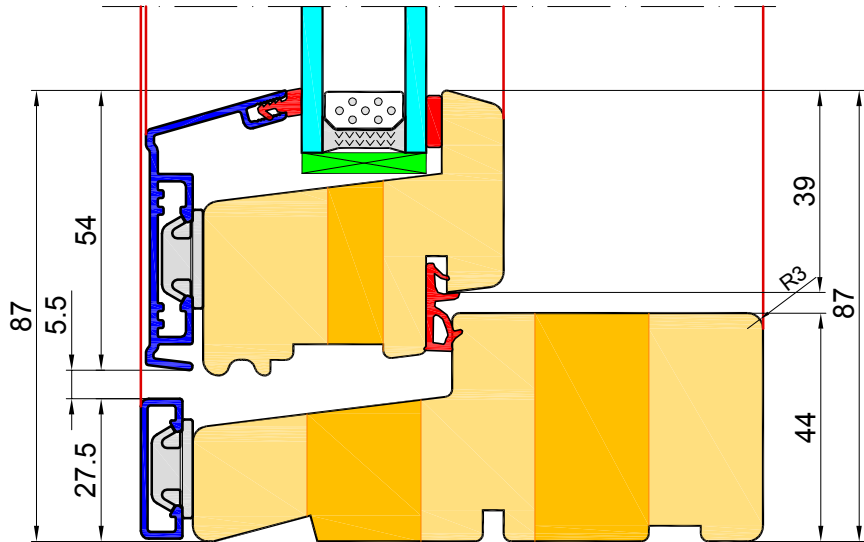

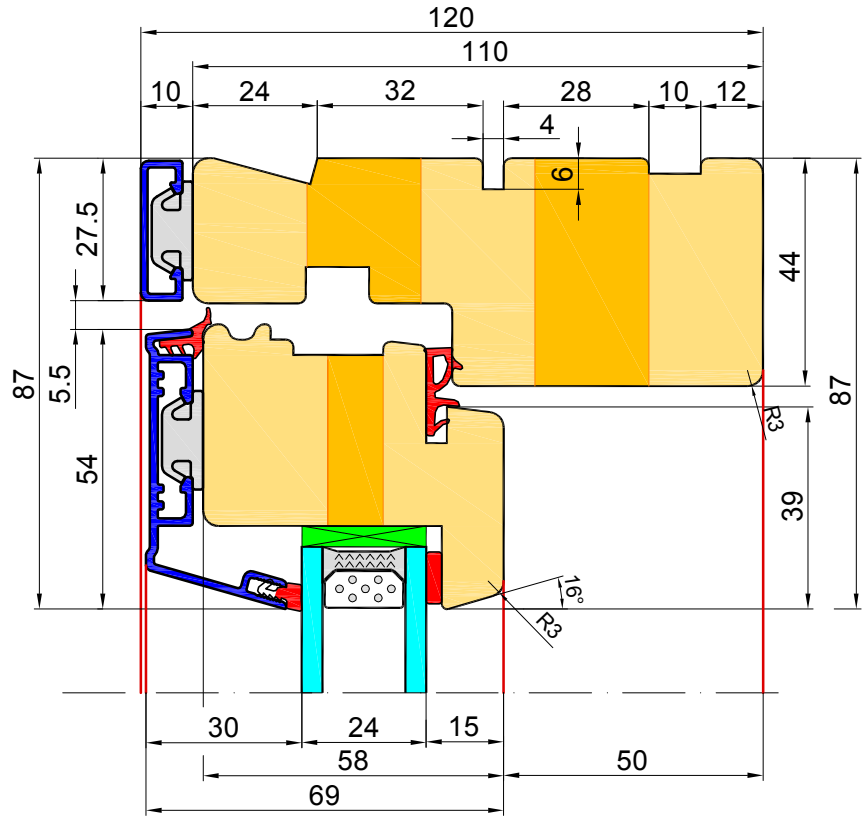

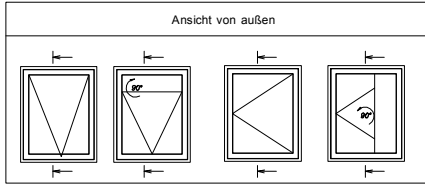
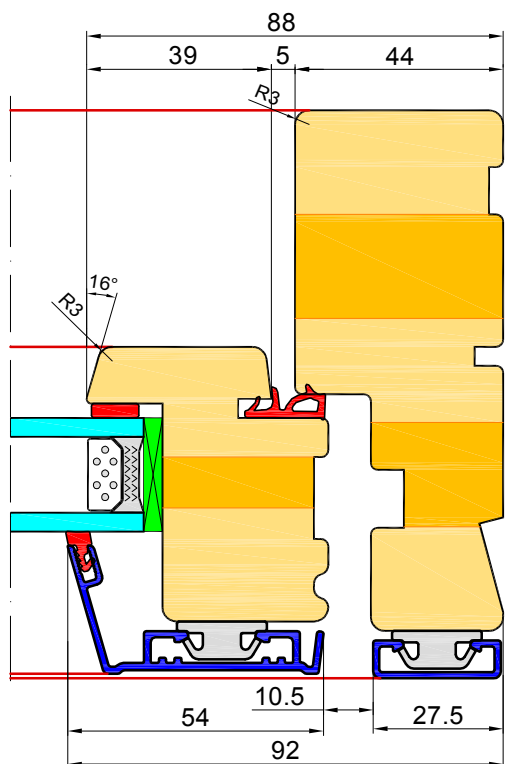
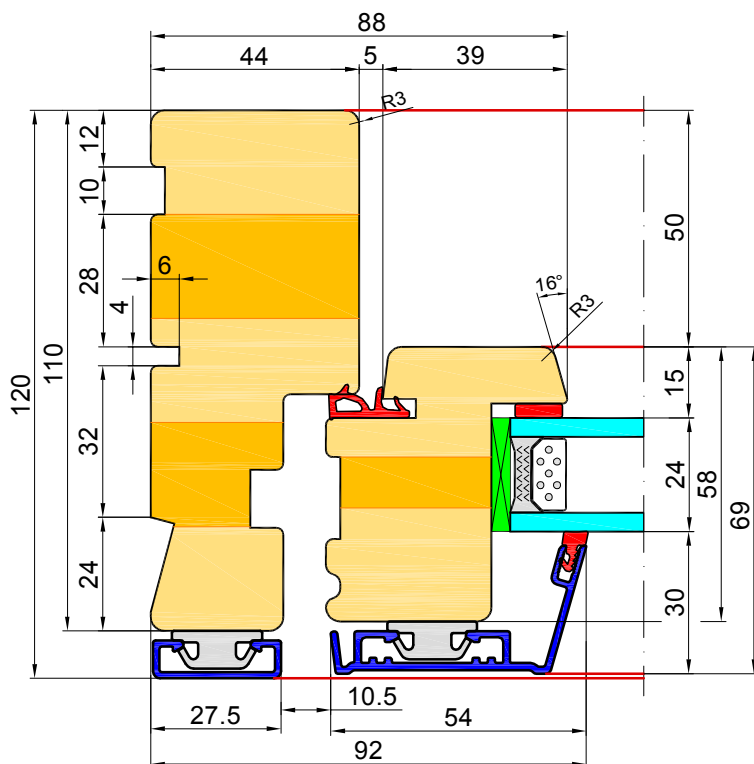
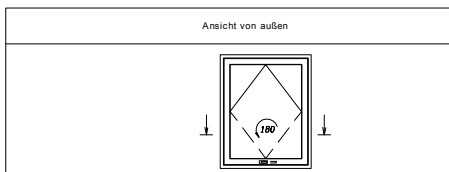
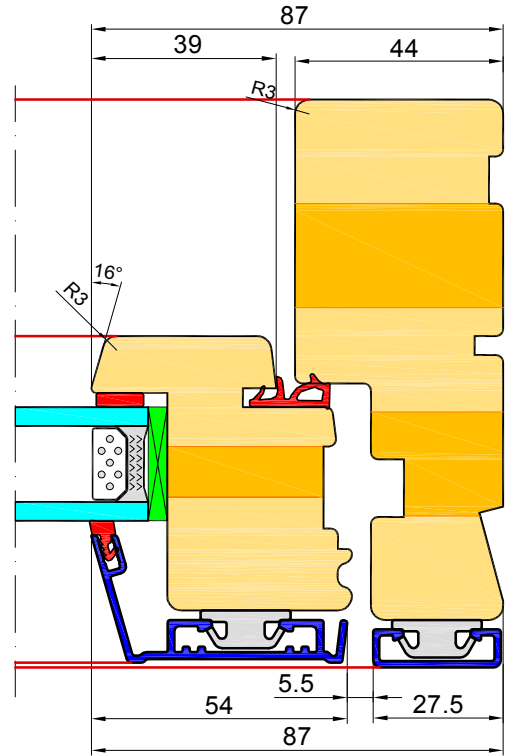
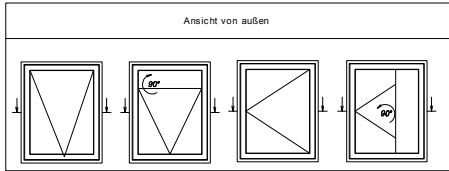
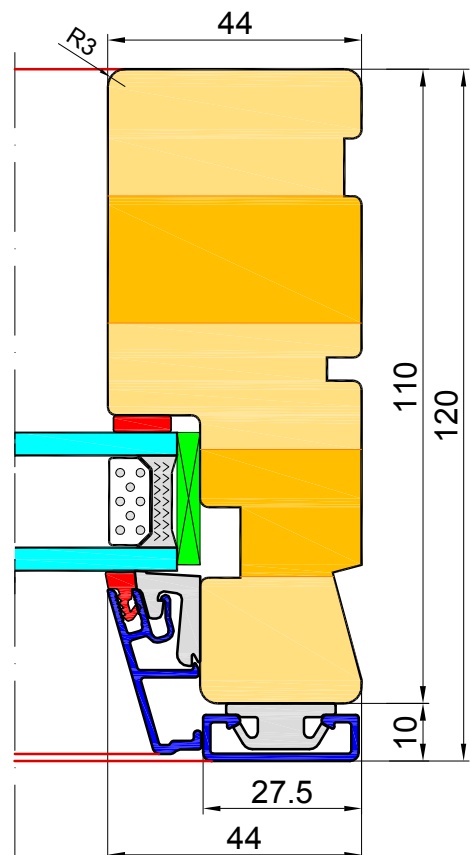
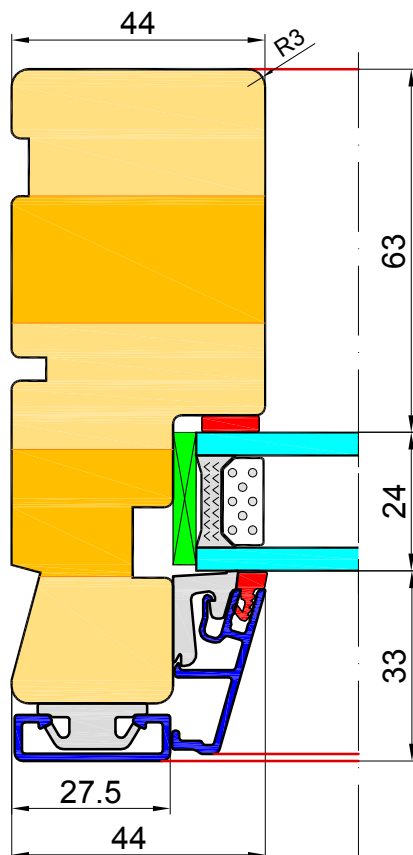
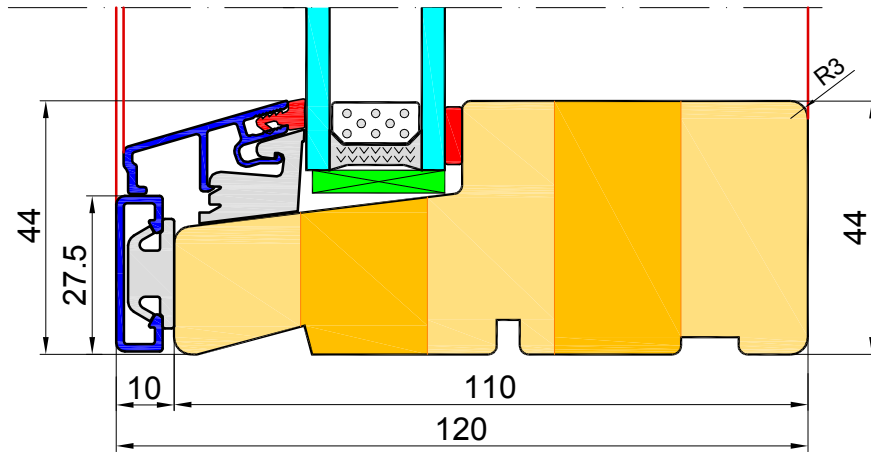
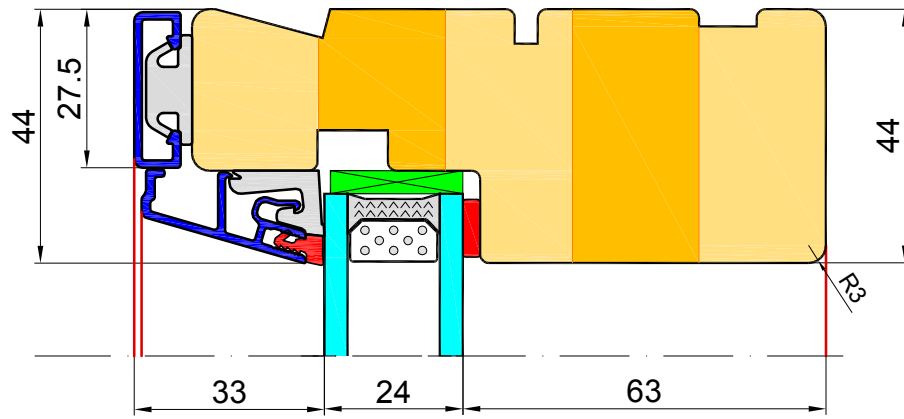
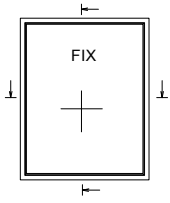

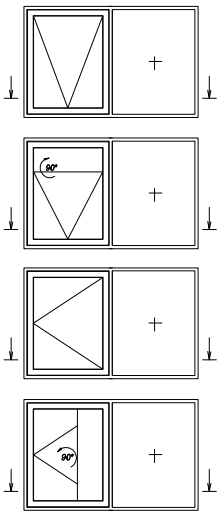
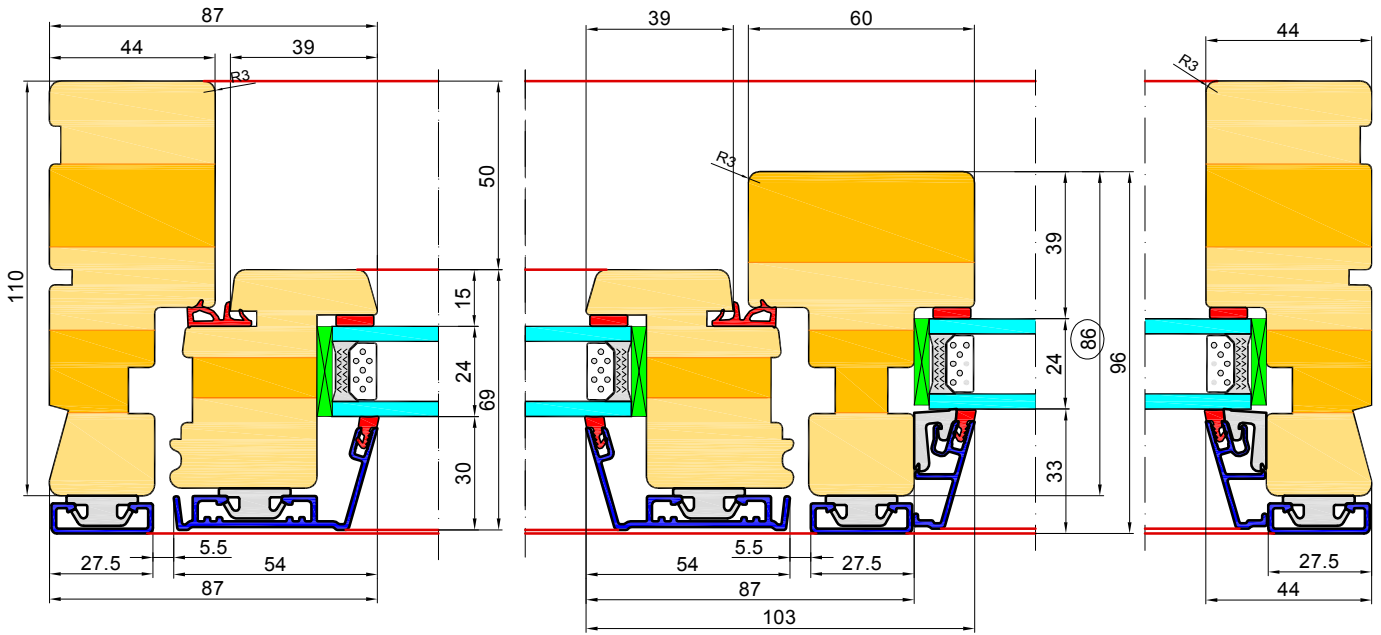

Pfosten/Kämpfer:
86mm, 98mm, 110mm

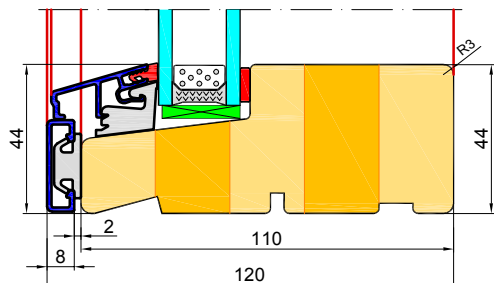
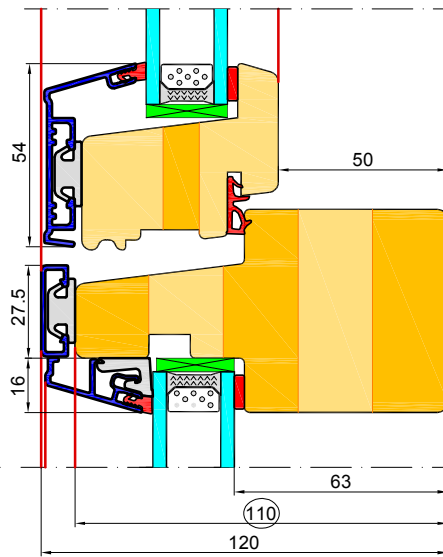
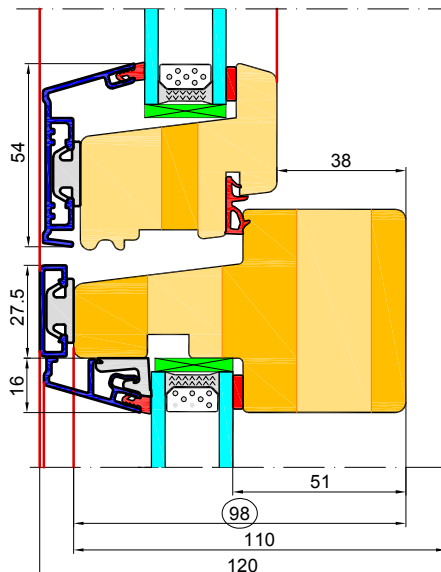
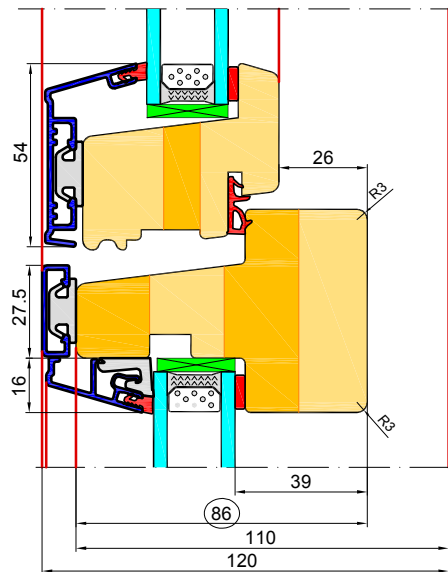
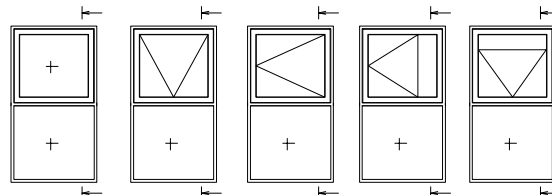
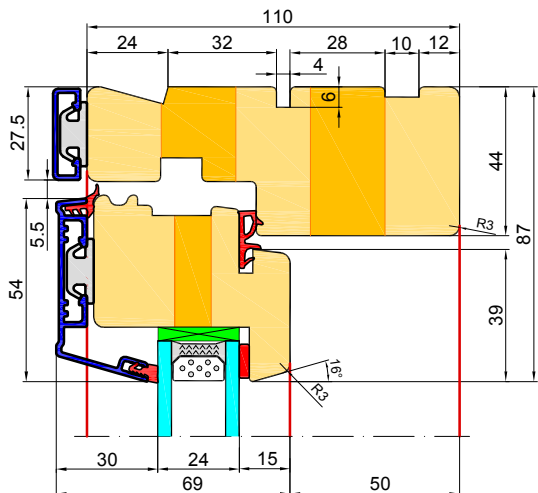

feststulp in Rahmen horizontal:
86mm, 98mm, 110mm

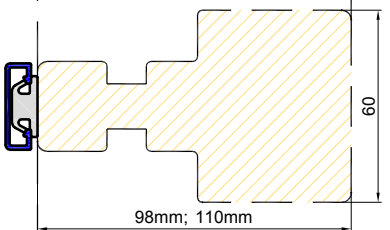
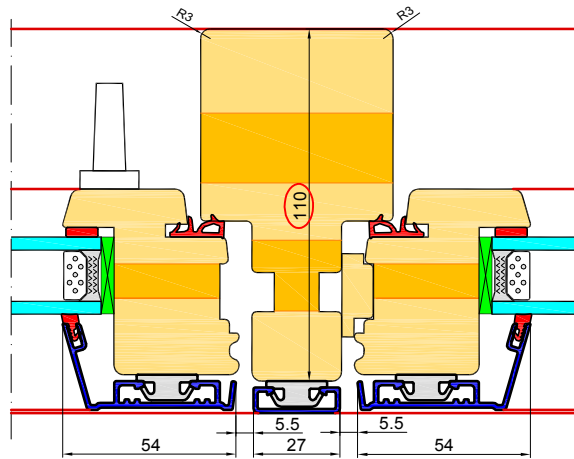
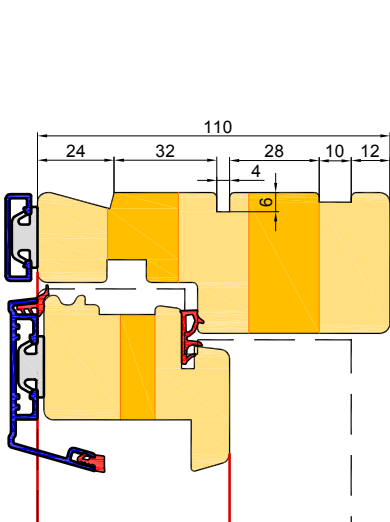
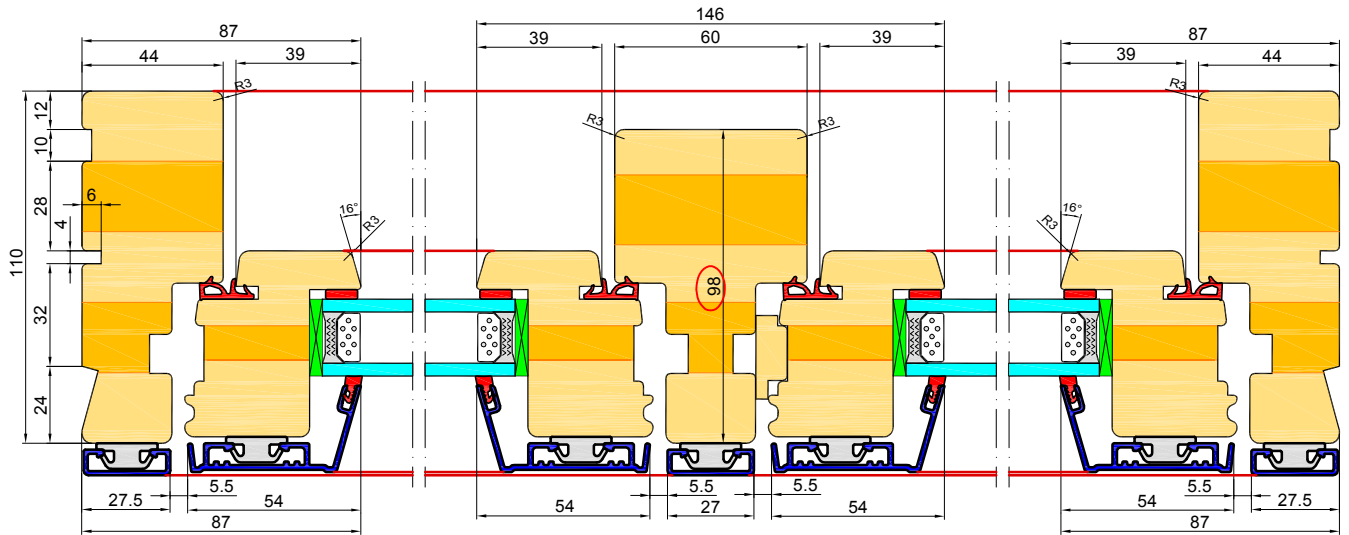
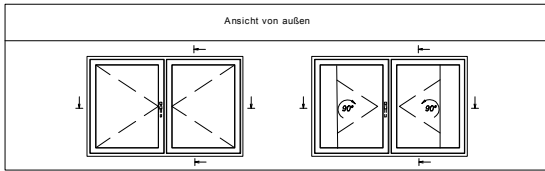

Stulp:
98mm, 110mm

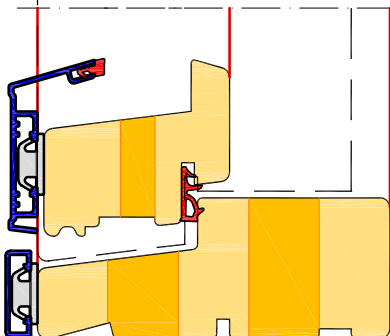

EURO ALU - Profil SOFT - FIX mit Ausgleich.

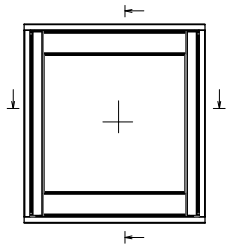

FIX mit Ausgleich:
- Seite 55 lub 104mm
- rauf und runter 104mm

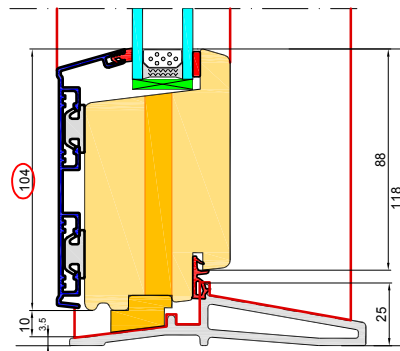
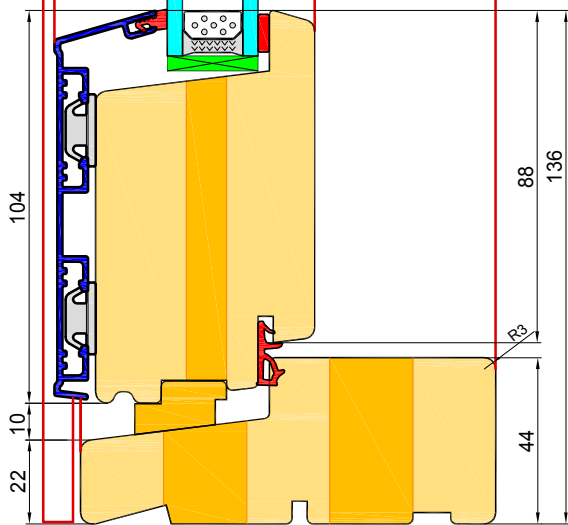
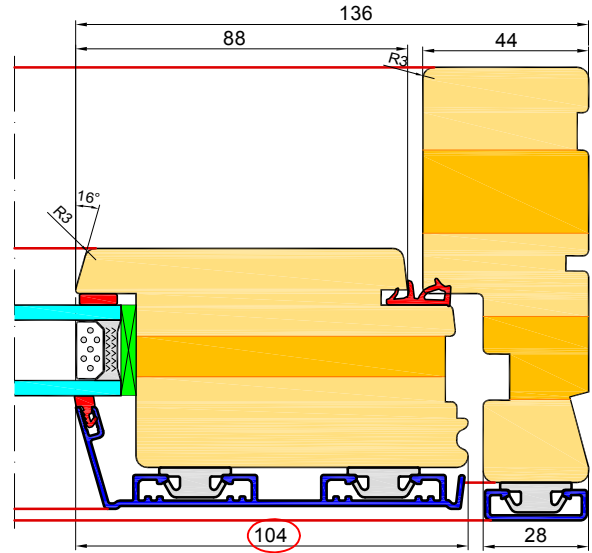
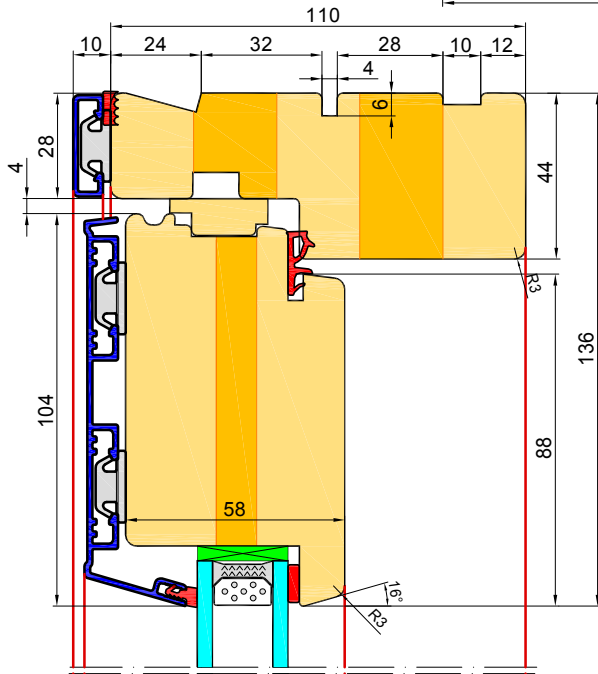
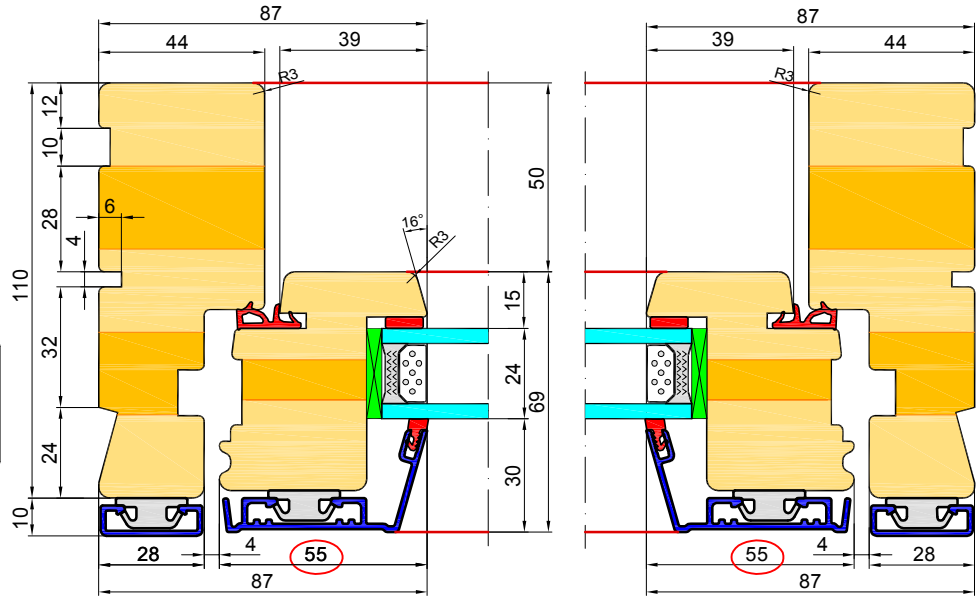

hölzerne schwelle

glasfaser schwelle

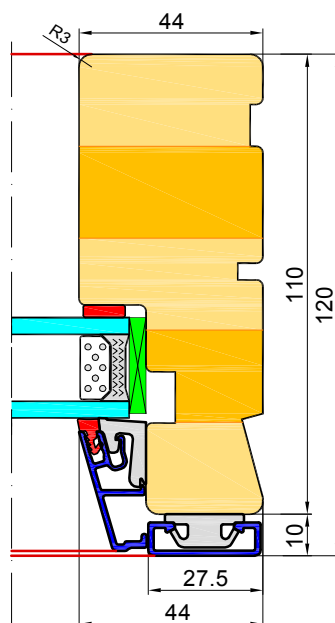
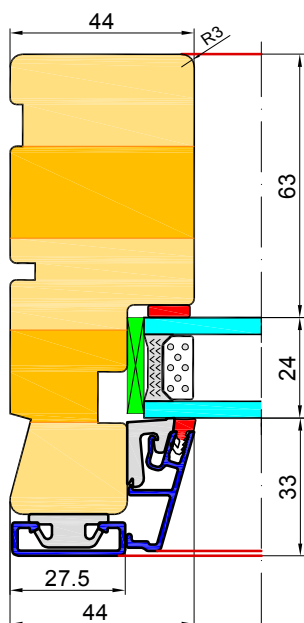
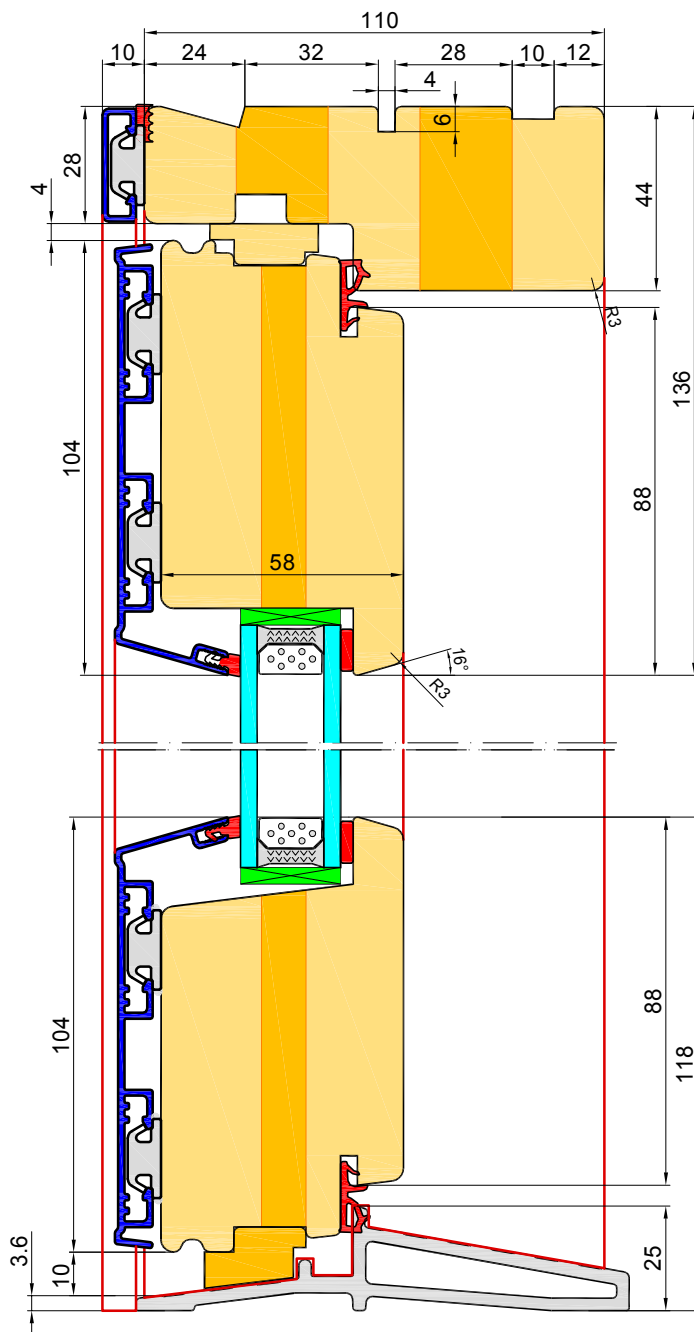
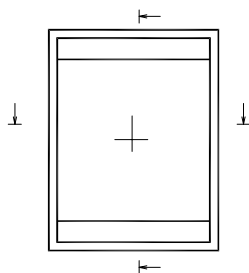

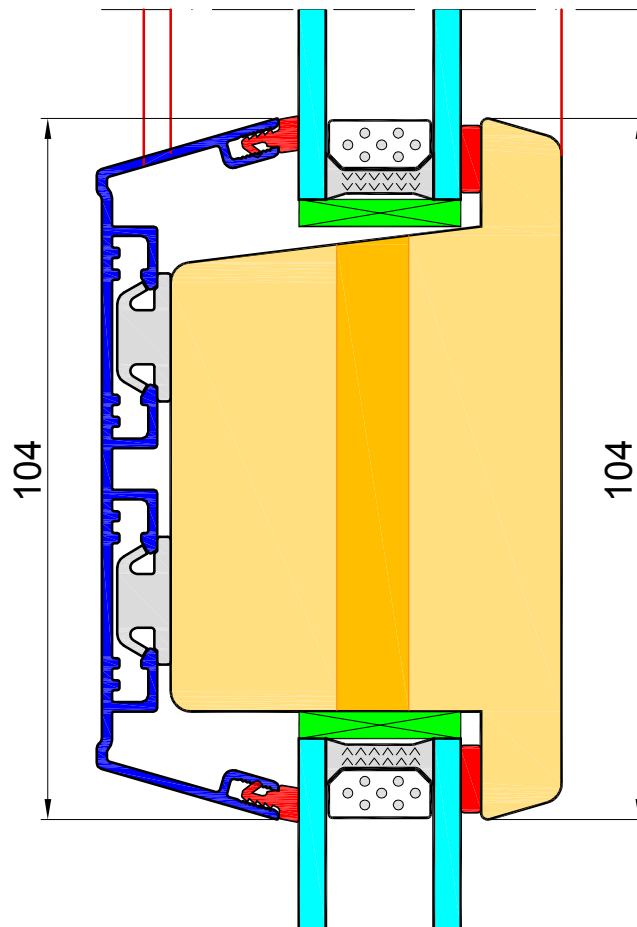
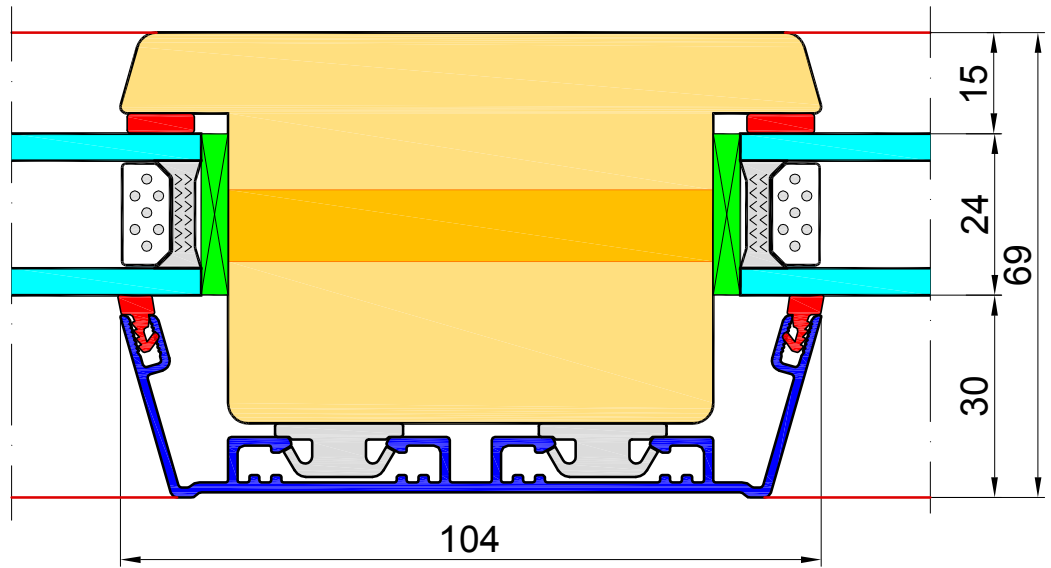
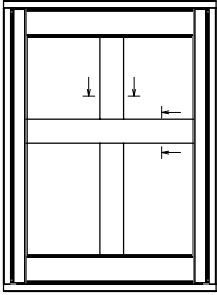

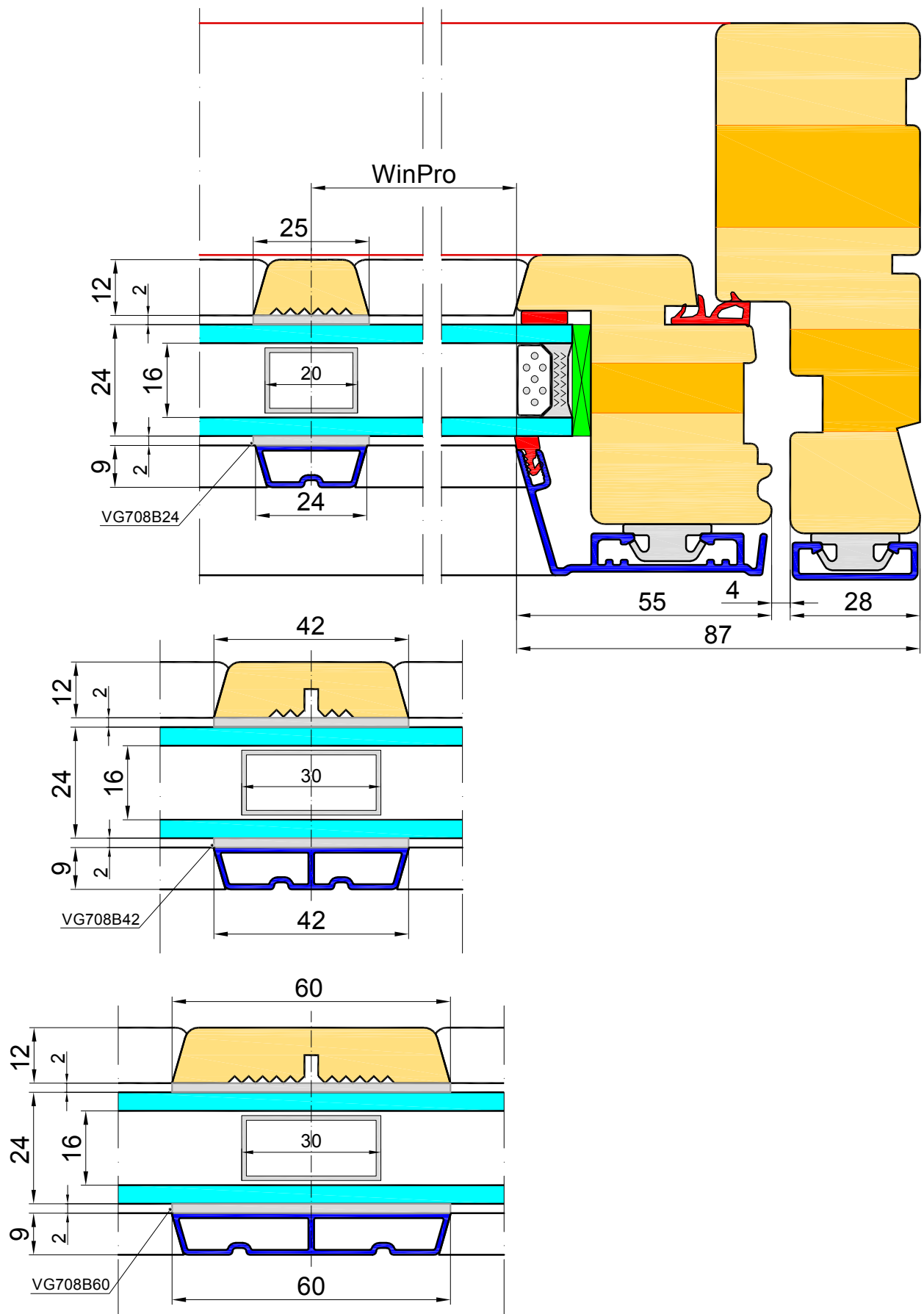

EURO ALU - schwelle

1. SCHWELLE 44mm.

Nut 10x10mm innen

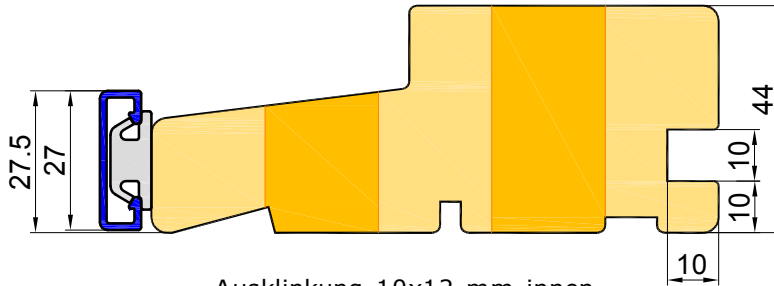

Ausklüpfung 10x12 mm innen

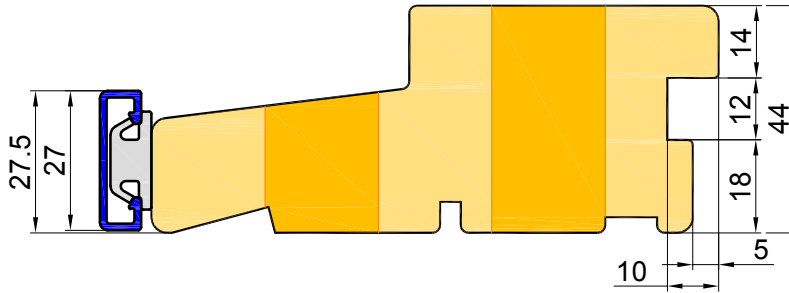

2. SCHWELLE 54mm.

Nut 10x10mm innen

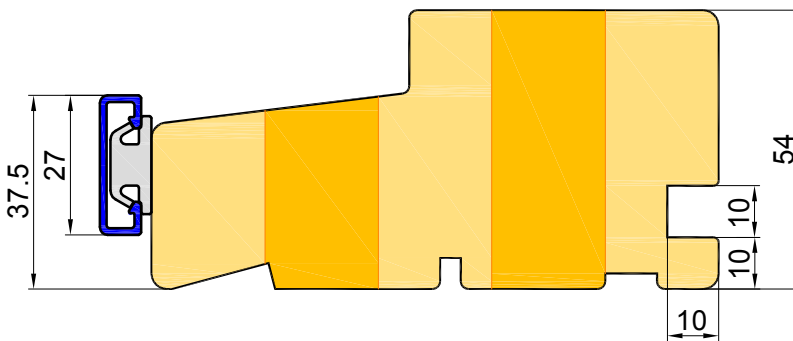

Ausklüpfung 10x15 mm außen

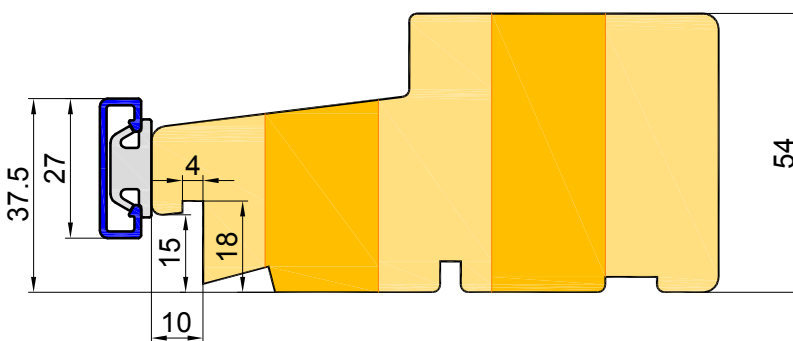

Nut 10x10mm innen und Ausklüpfung 10x15 mm außen

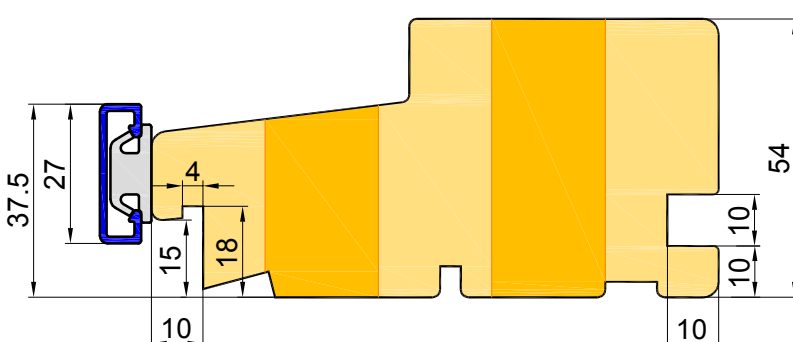

Aluminiumfensterbank _ ALURON

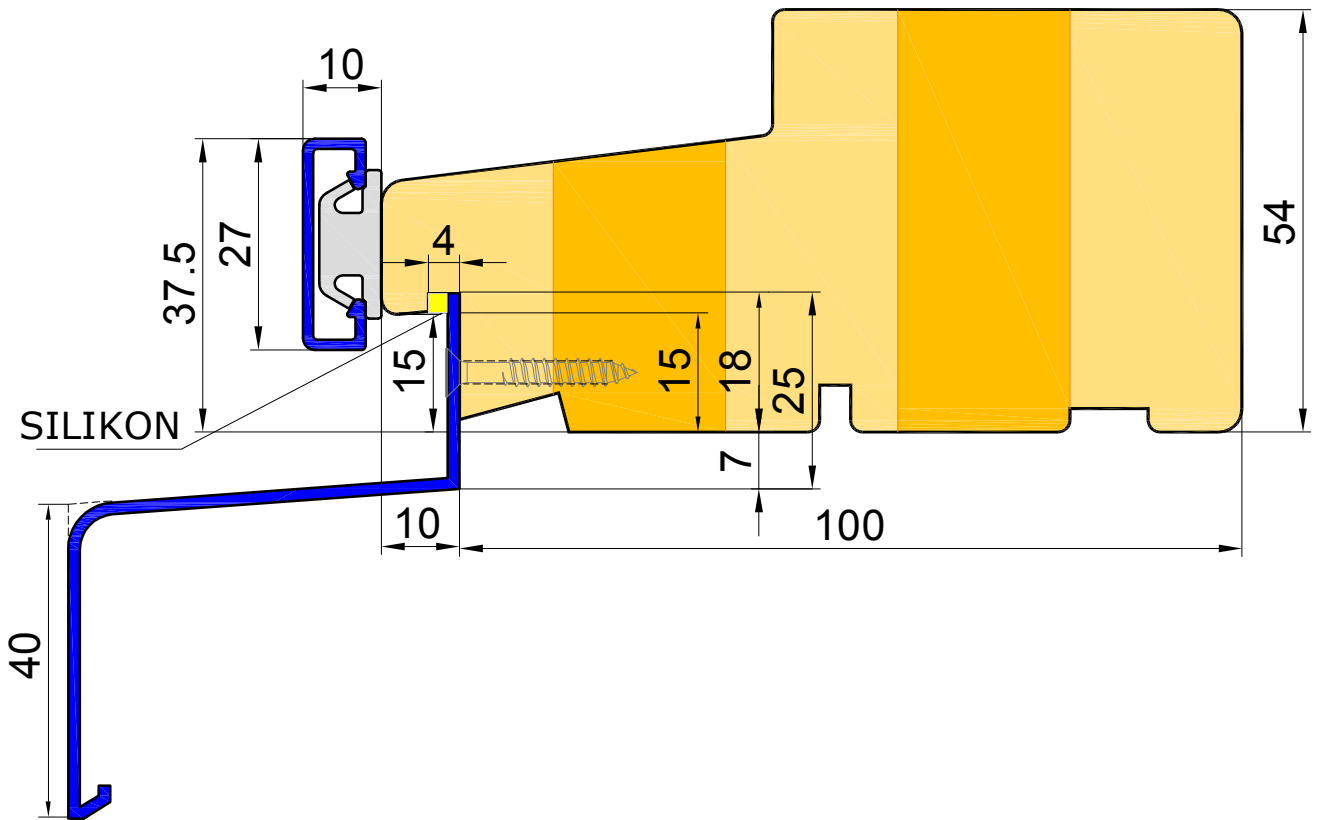

Aluminiumfensterbank _ Gutmann Z-22

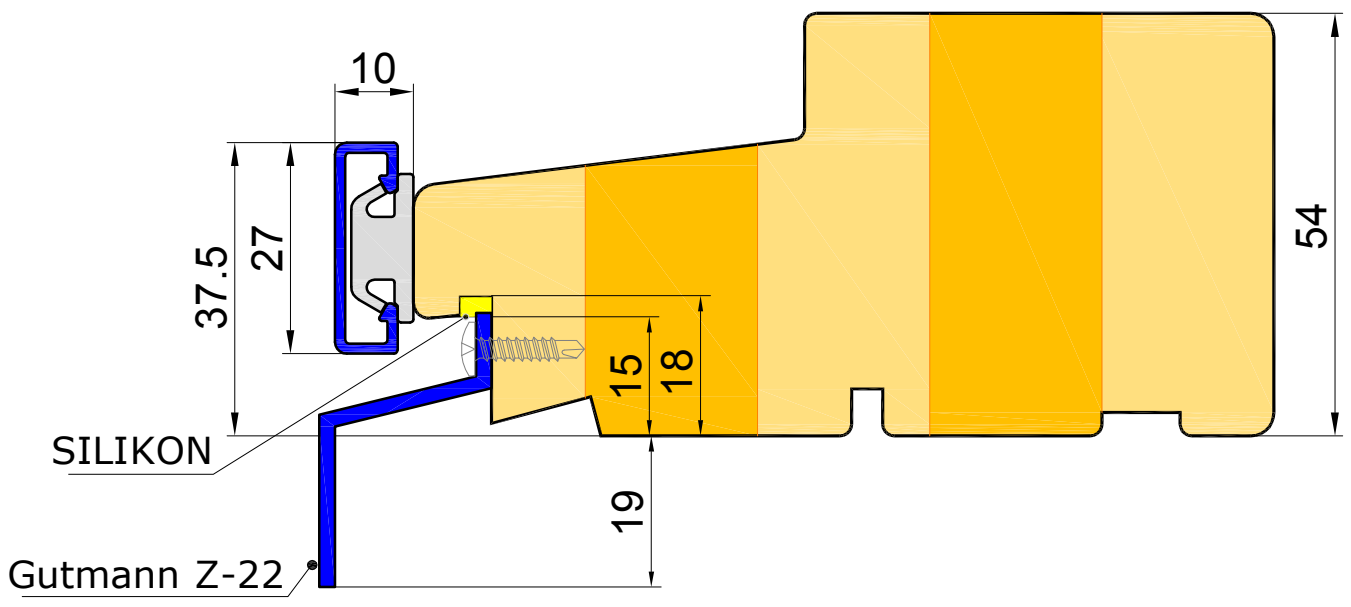

EURO - Profil SOFT - Fensterverbindung.

Schwelle 54mm. Ausklinkung 10x15 mm außen.

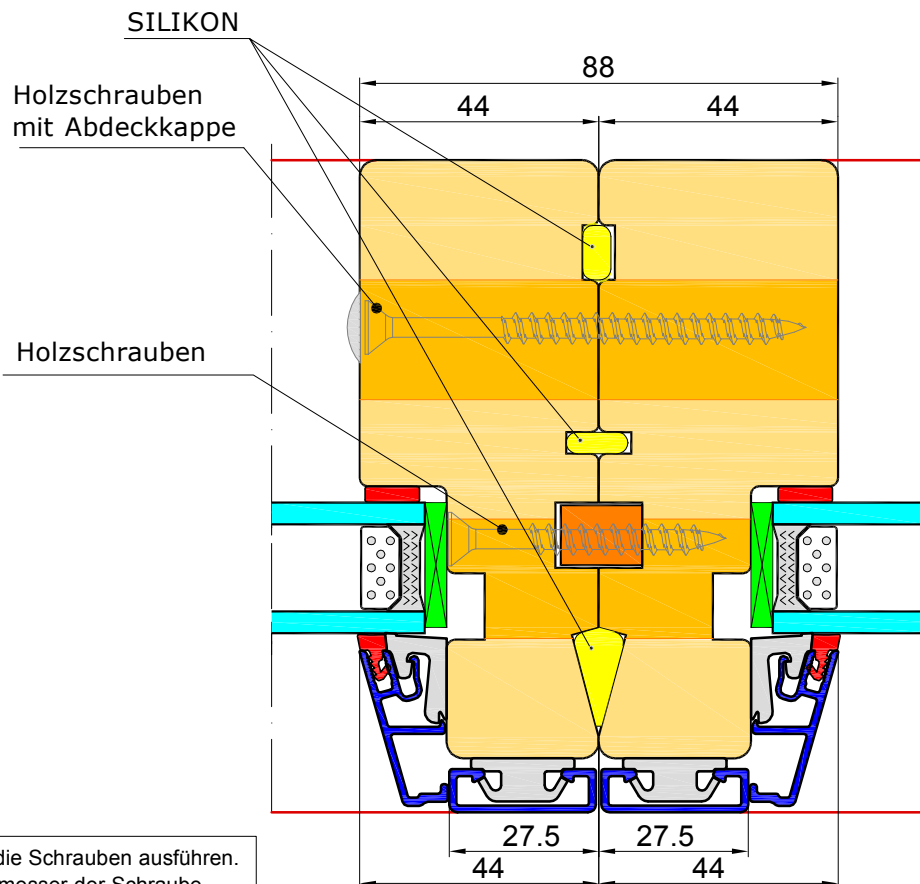
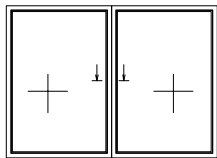

Achtung: Bitte Bohrlöcher für die Schrauben ausführen.
Bohrergröße = Mittlerer Durchmesser der Schraube

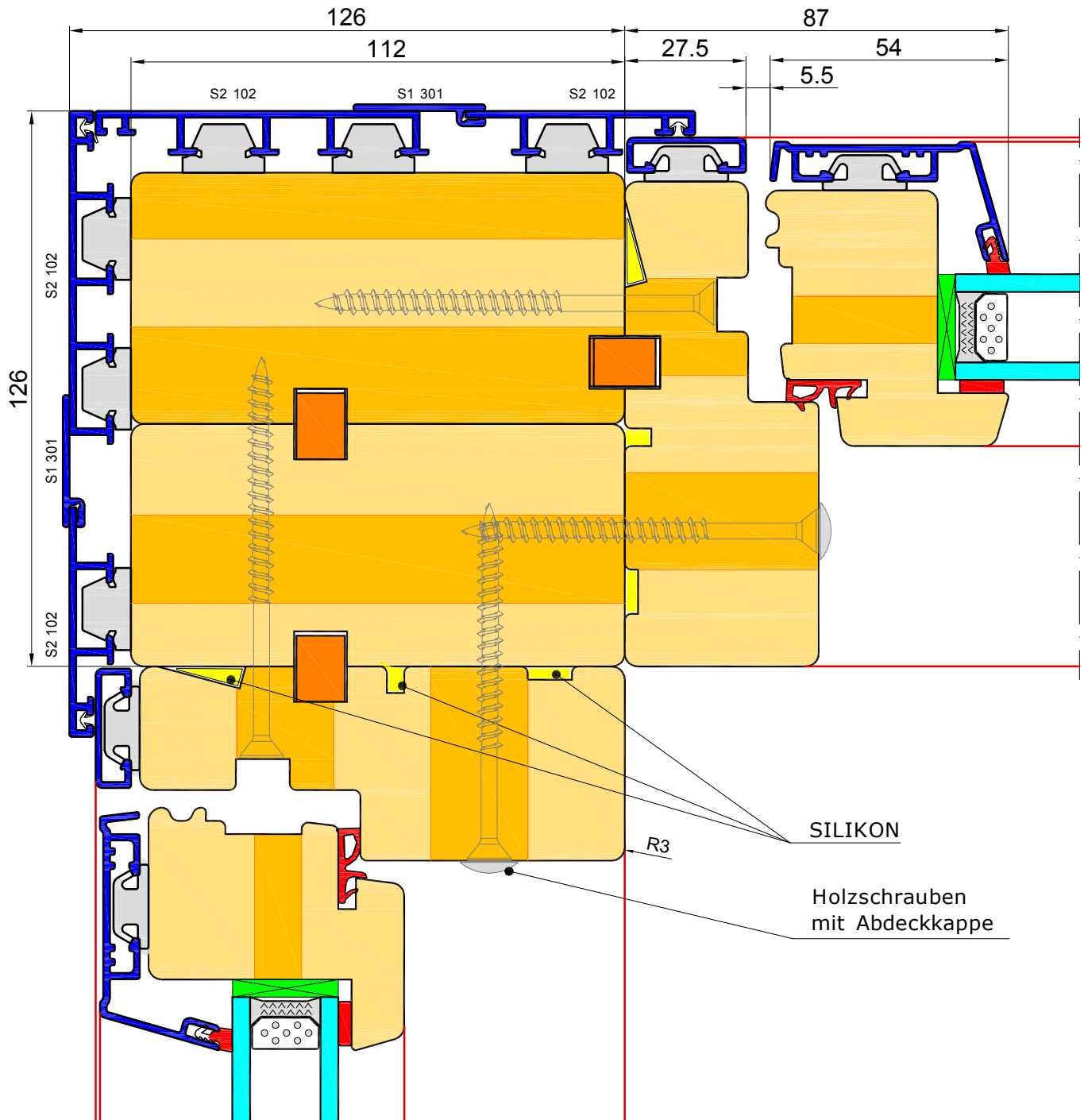
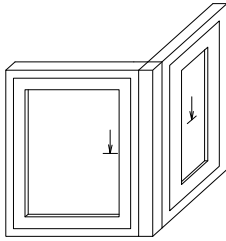

Achtung: Bitte Bohrlöcher für die Schrauben ausführen.
Bohrergröße = Mittlerer Durchmesser der Schraube

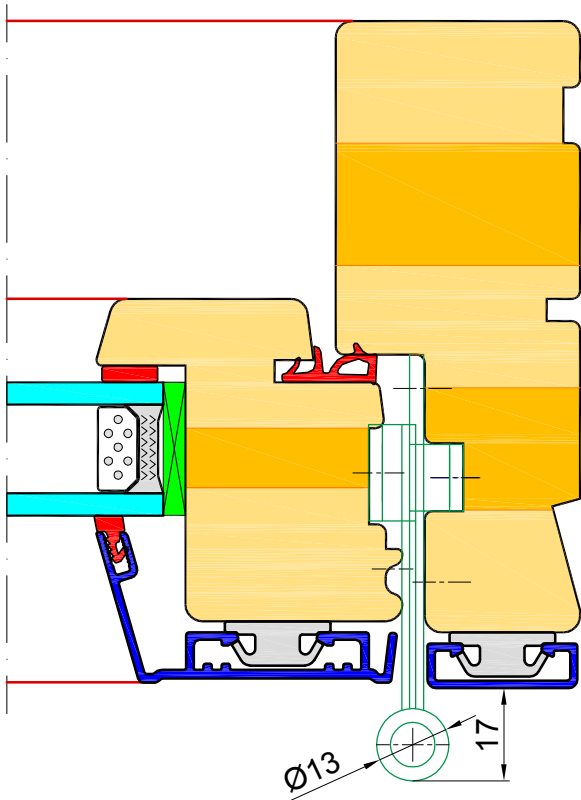
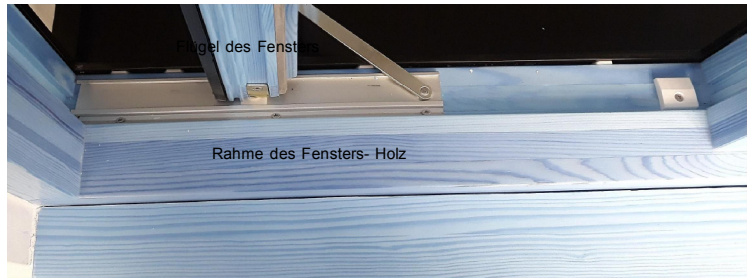
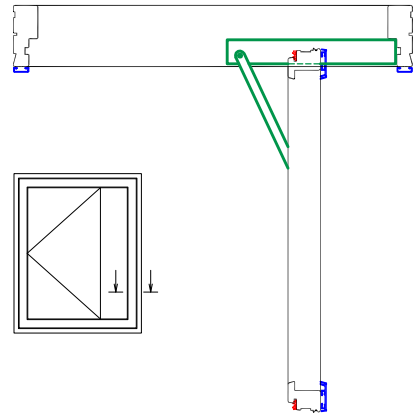
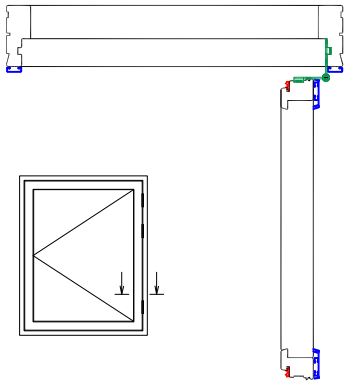

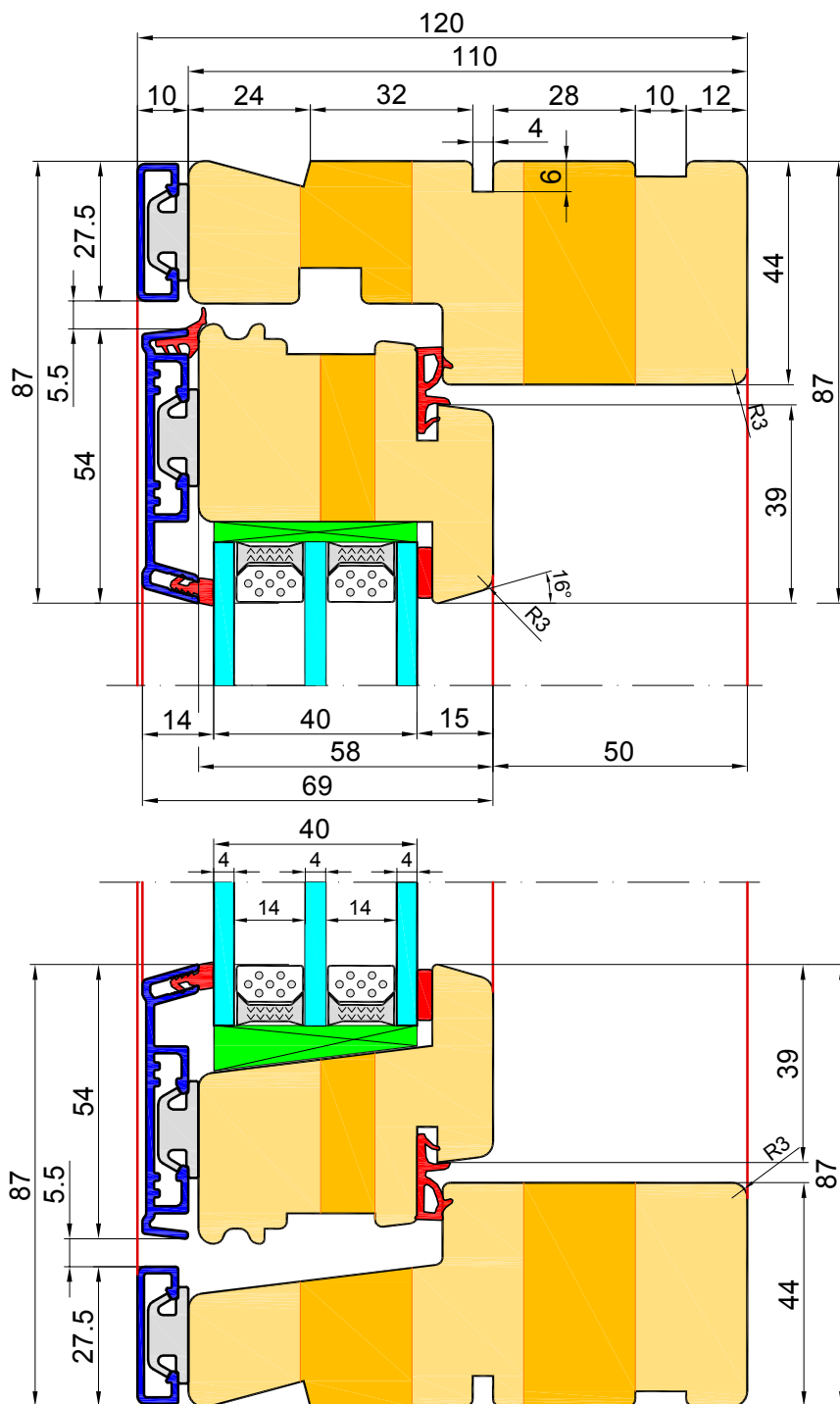
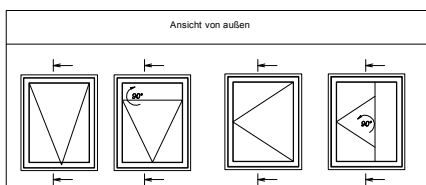

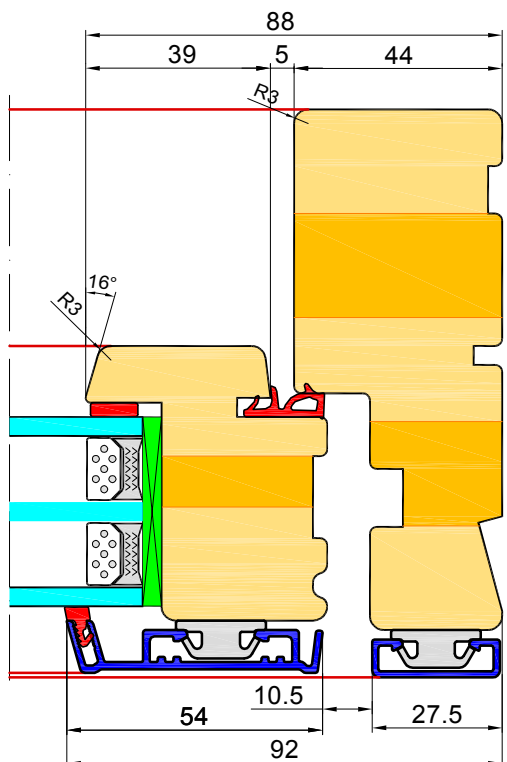
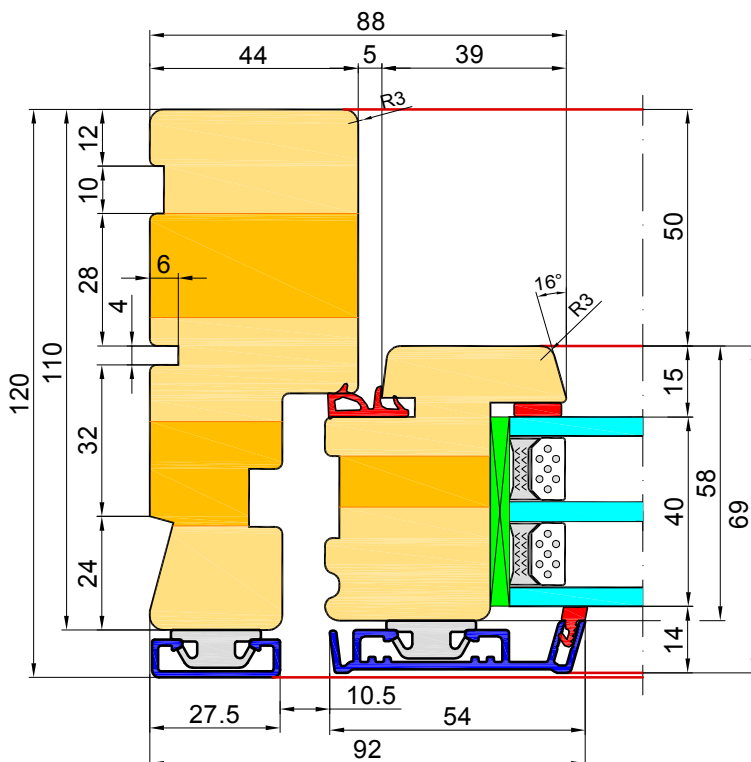
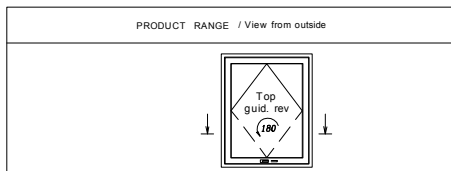
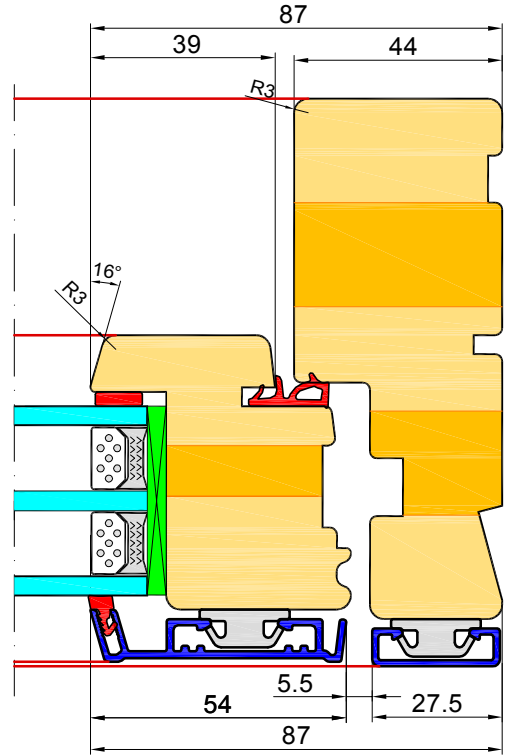
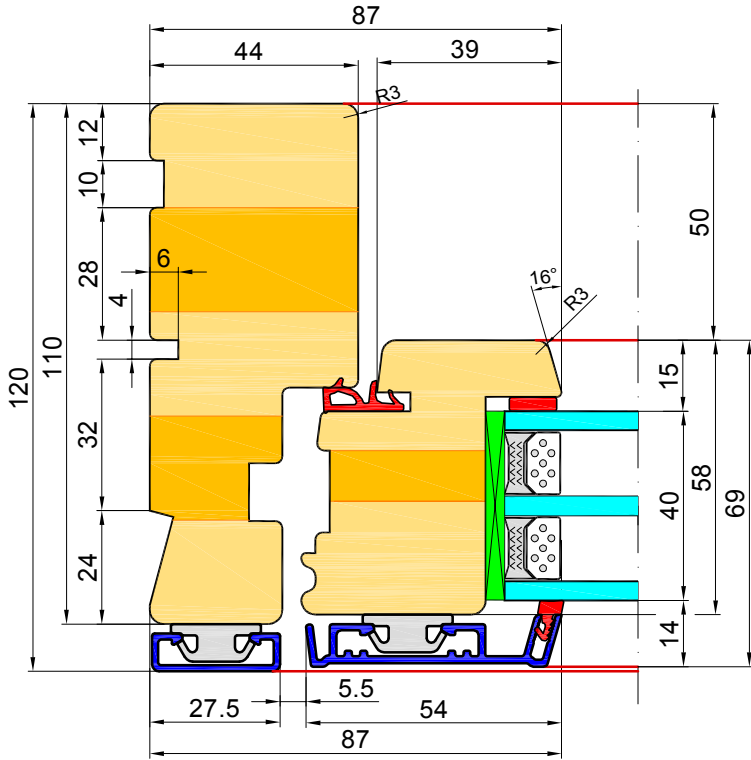
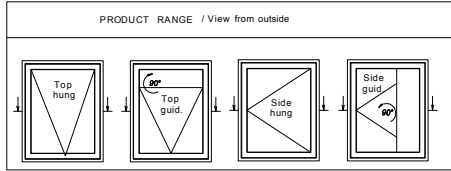

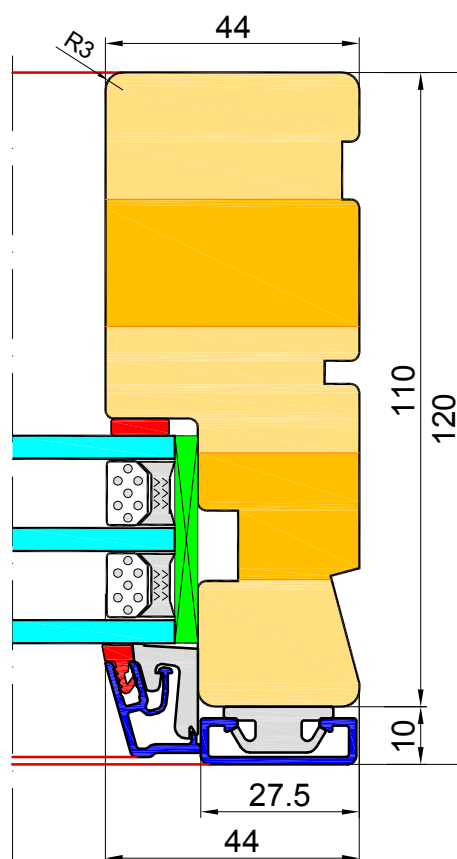
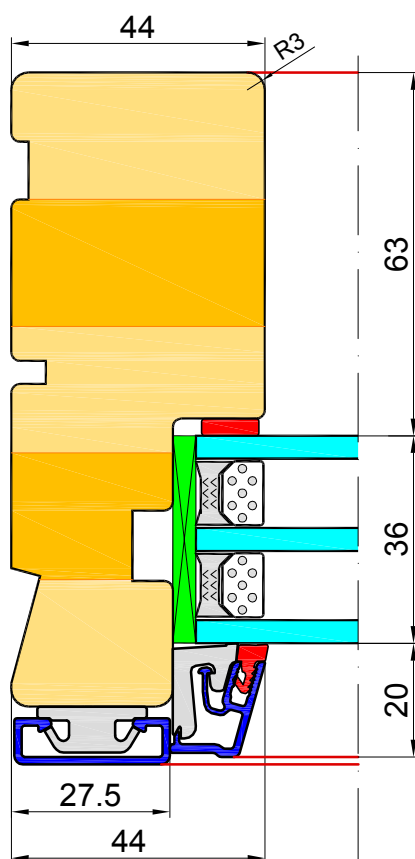
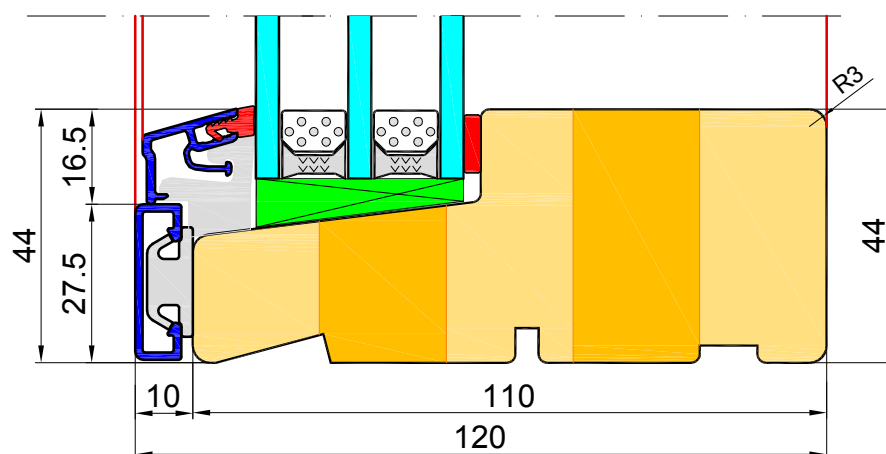
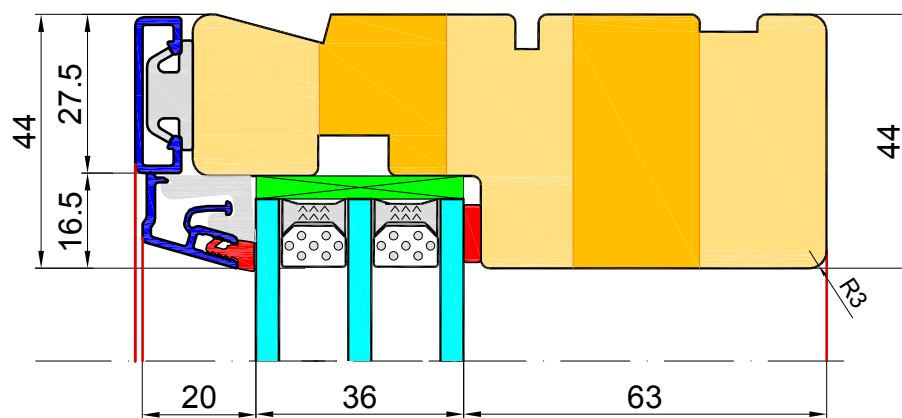
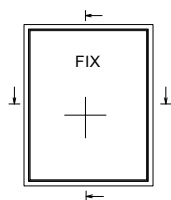

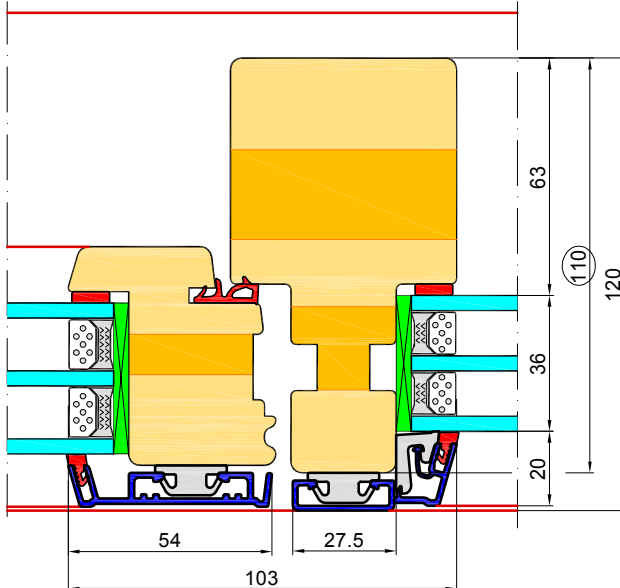
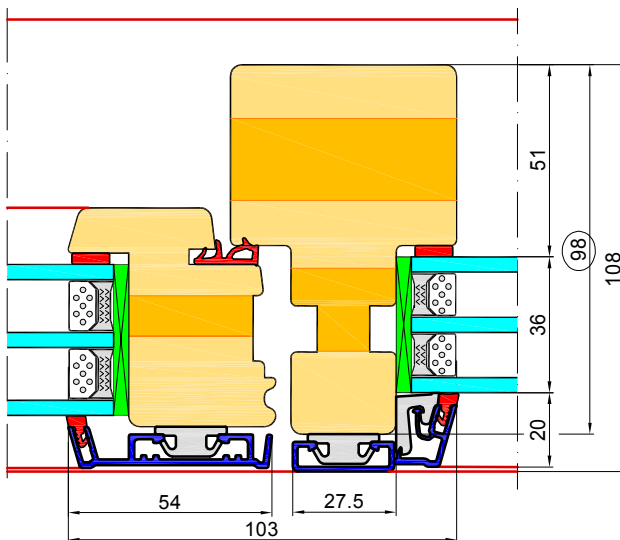
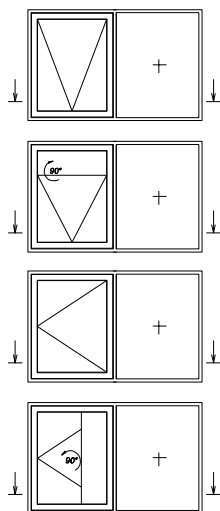
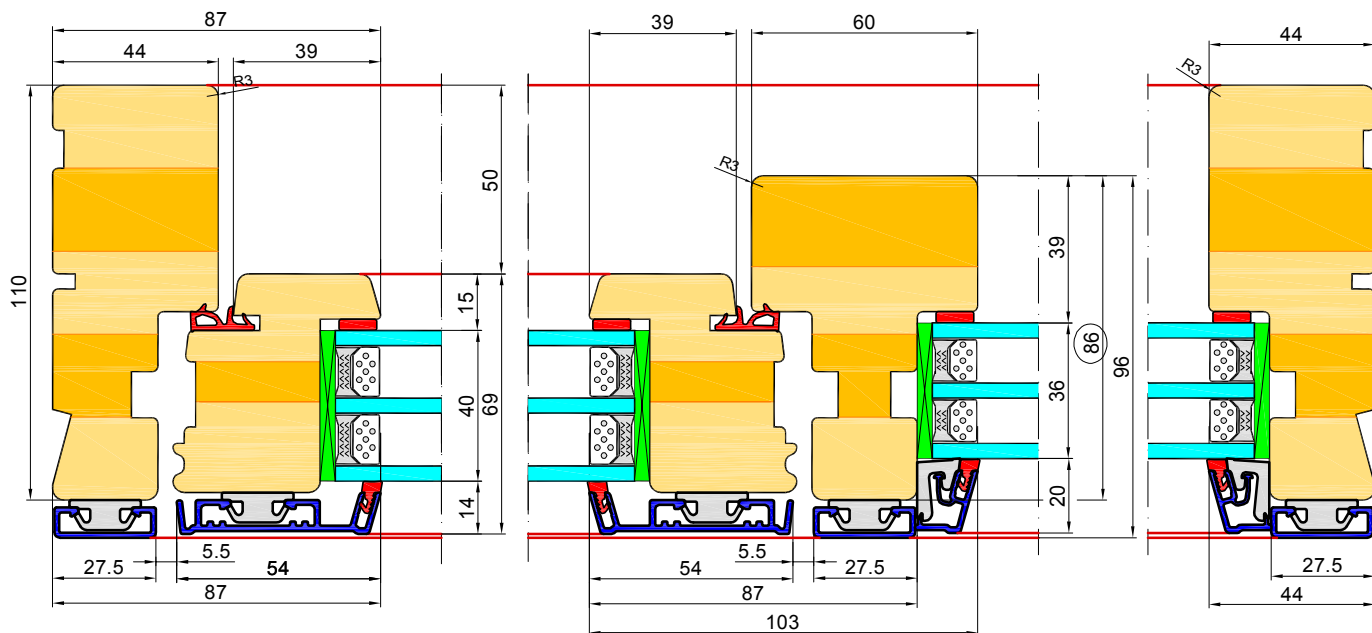

Pfosten/Kämpfer:
86mm, 98mm, 110mm

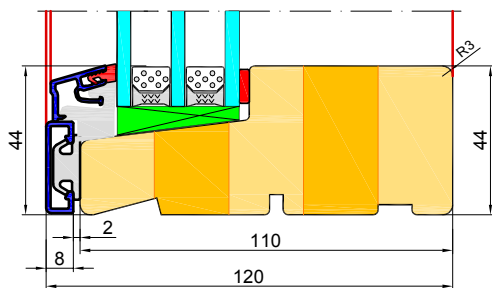
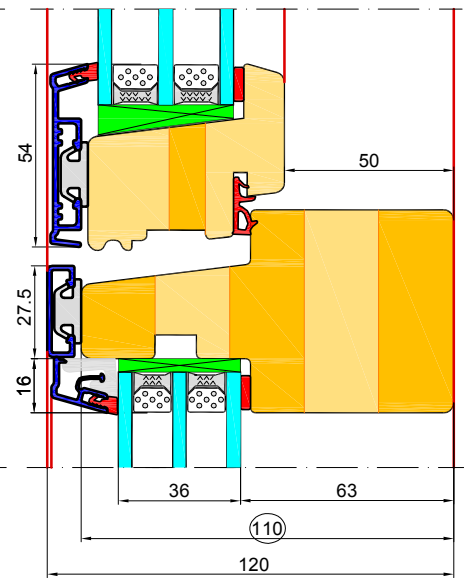
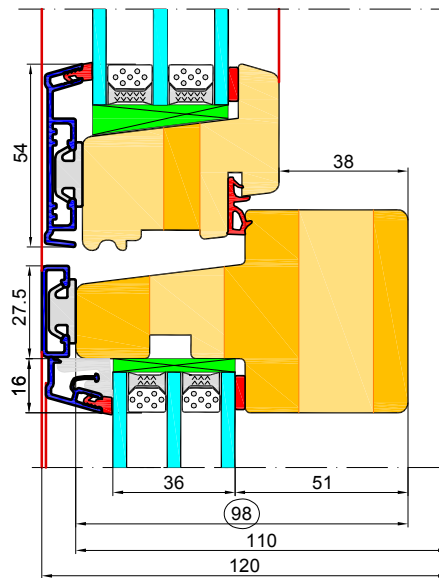
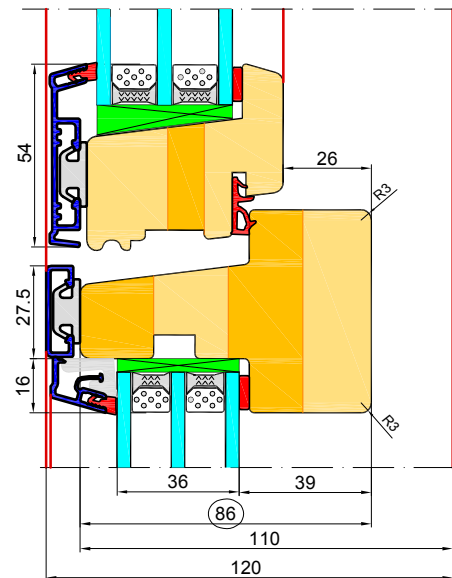
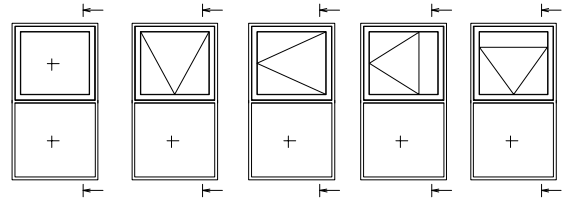
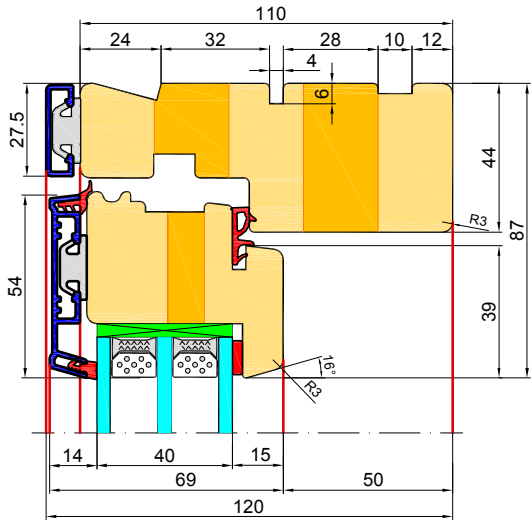

feststulp in Rahmen horizontal:
86mm, 98mm, 110mm

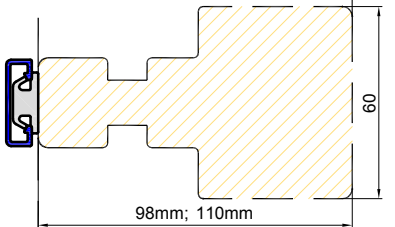
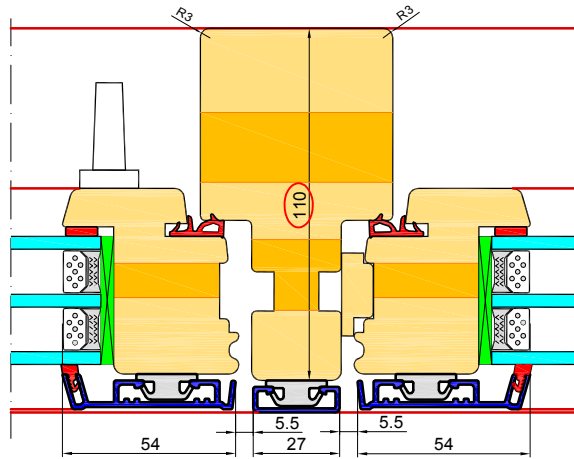
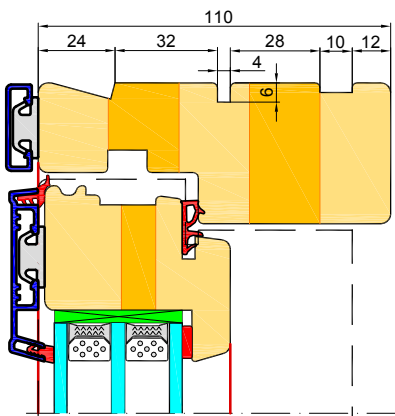
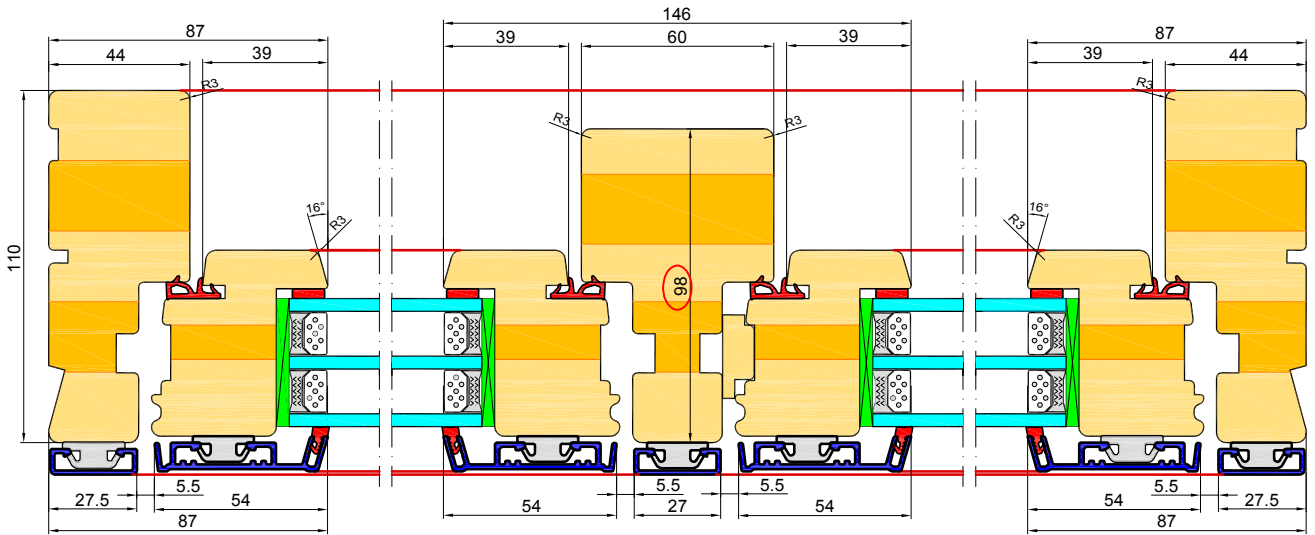
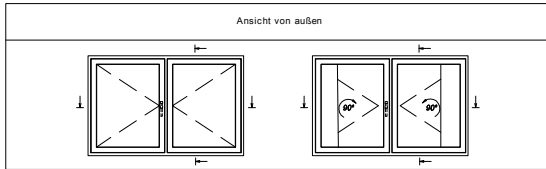

Stulp:
98mm, 110mm

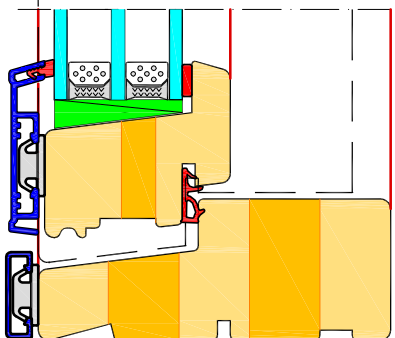

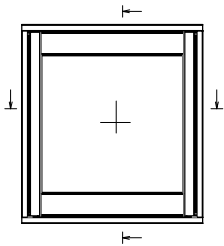

FIX mit Ausgleich:
- Seite 55 lub 104mm
- rauf und runter 104mm

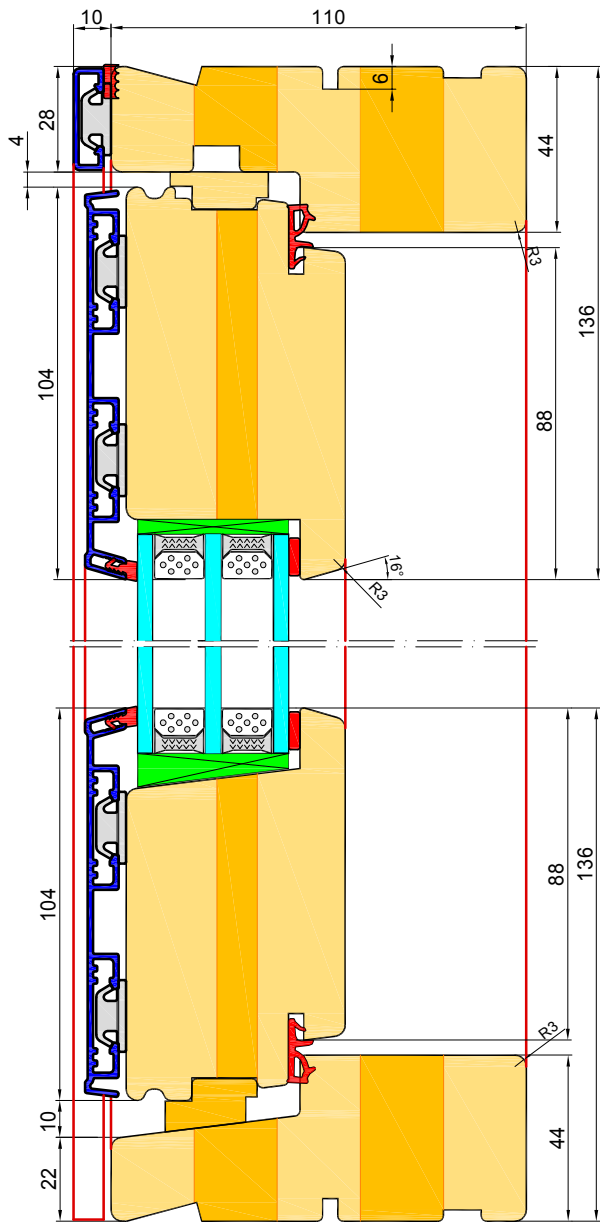
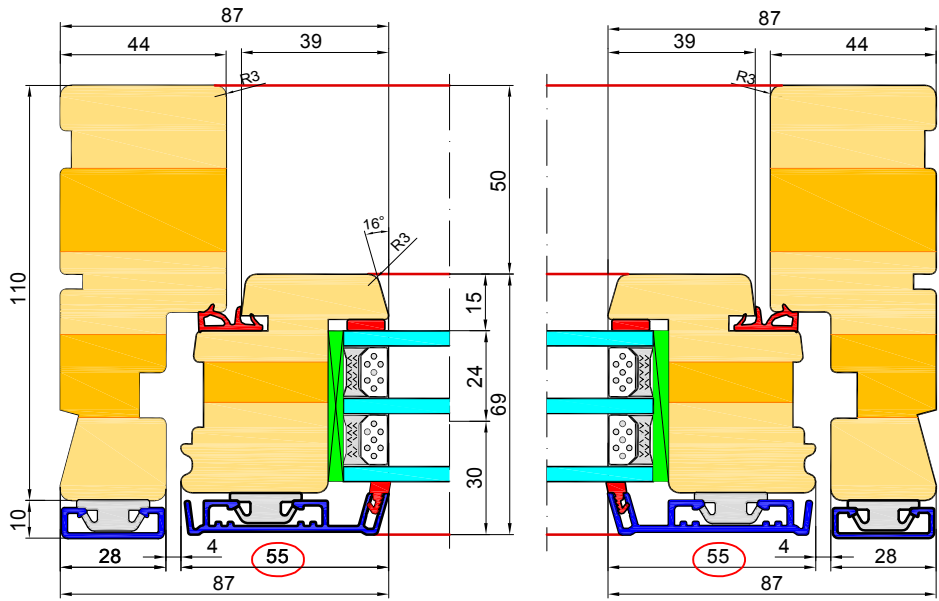

hölzerne schwelle

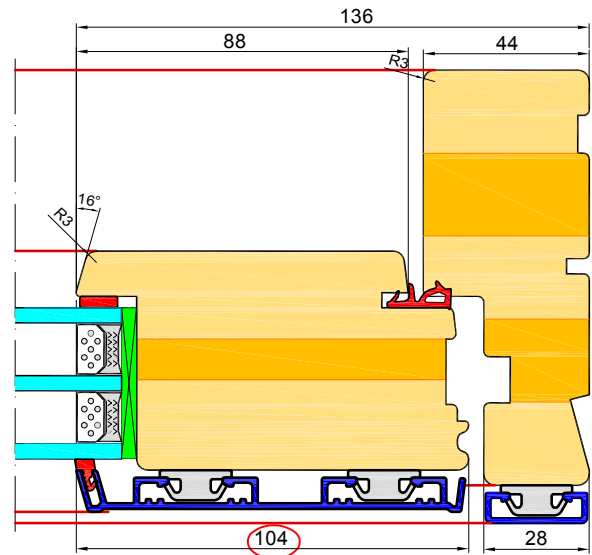

glasfaser schwelle

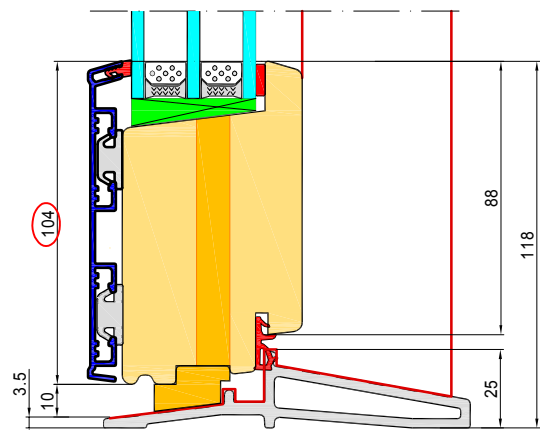

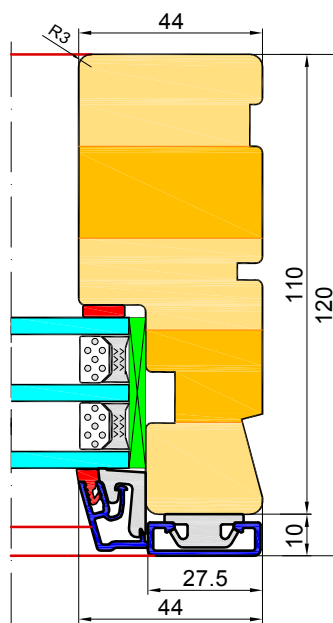
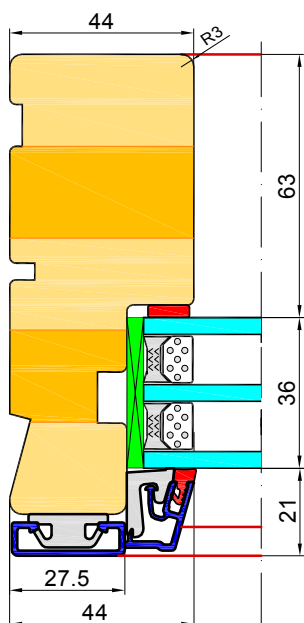
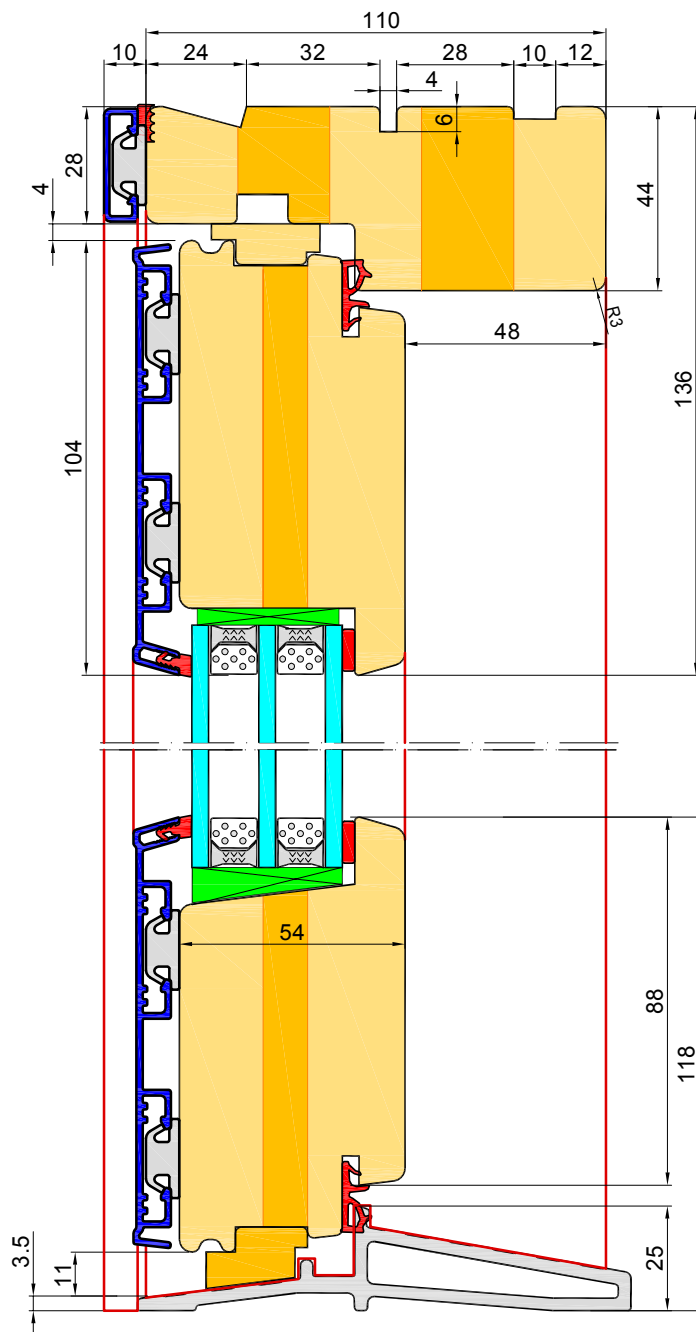
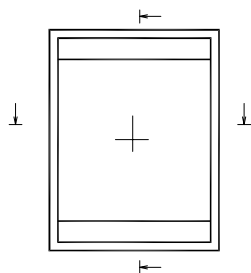

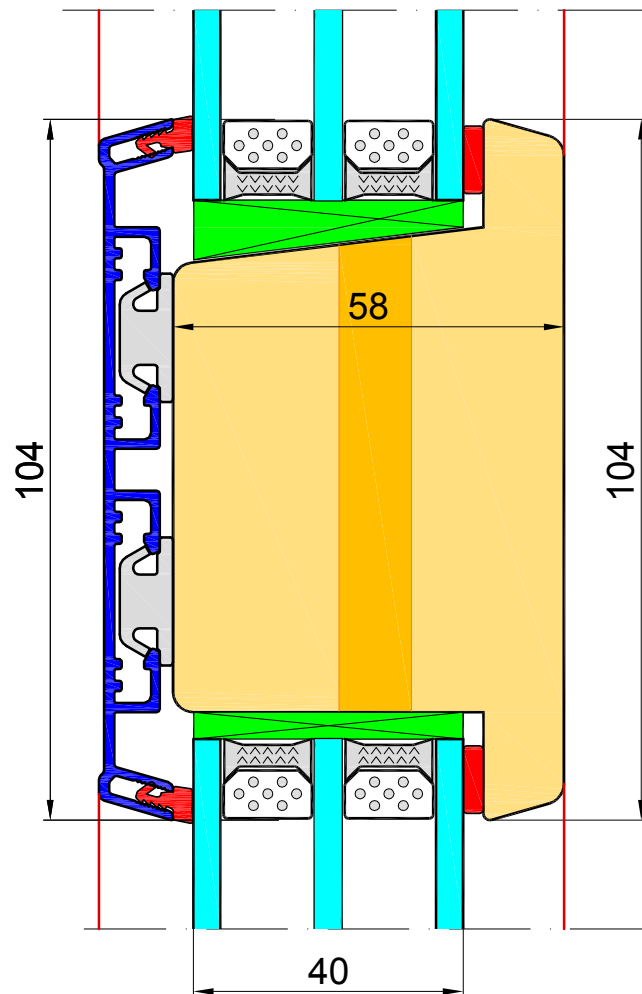
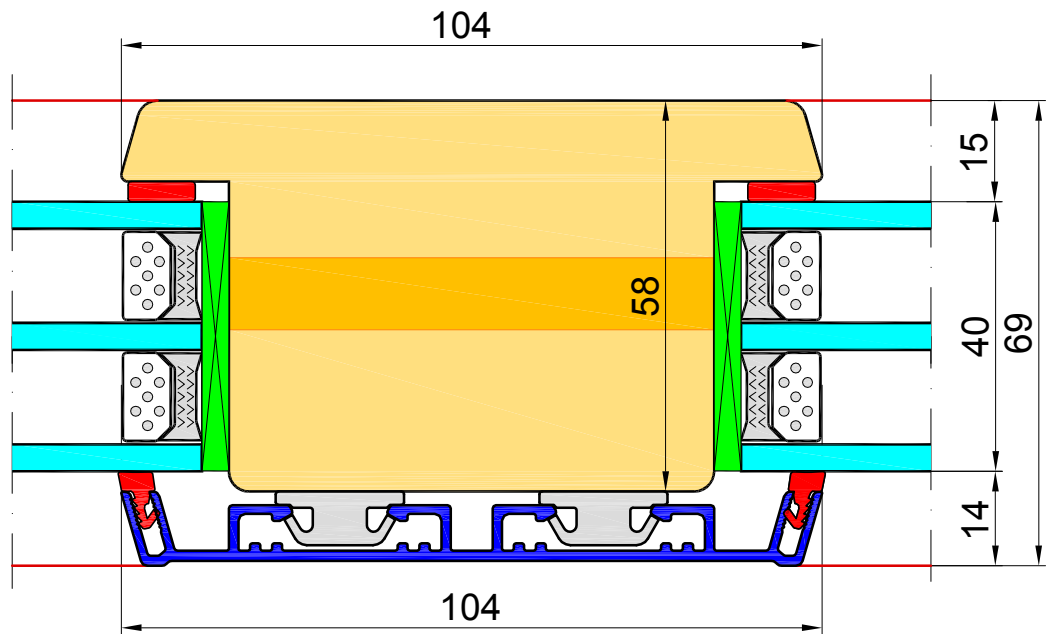
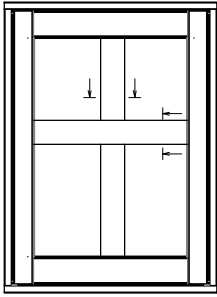

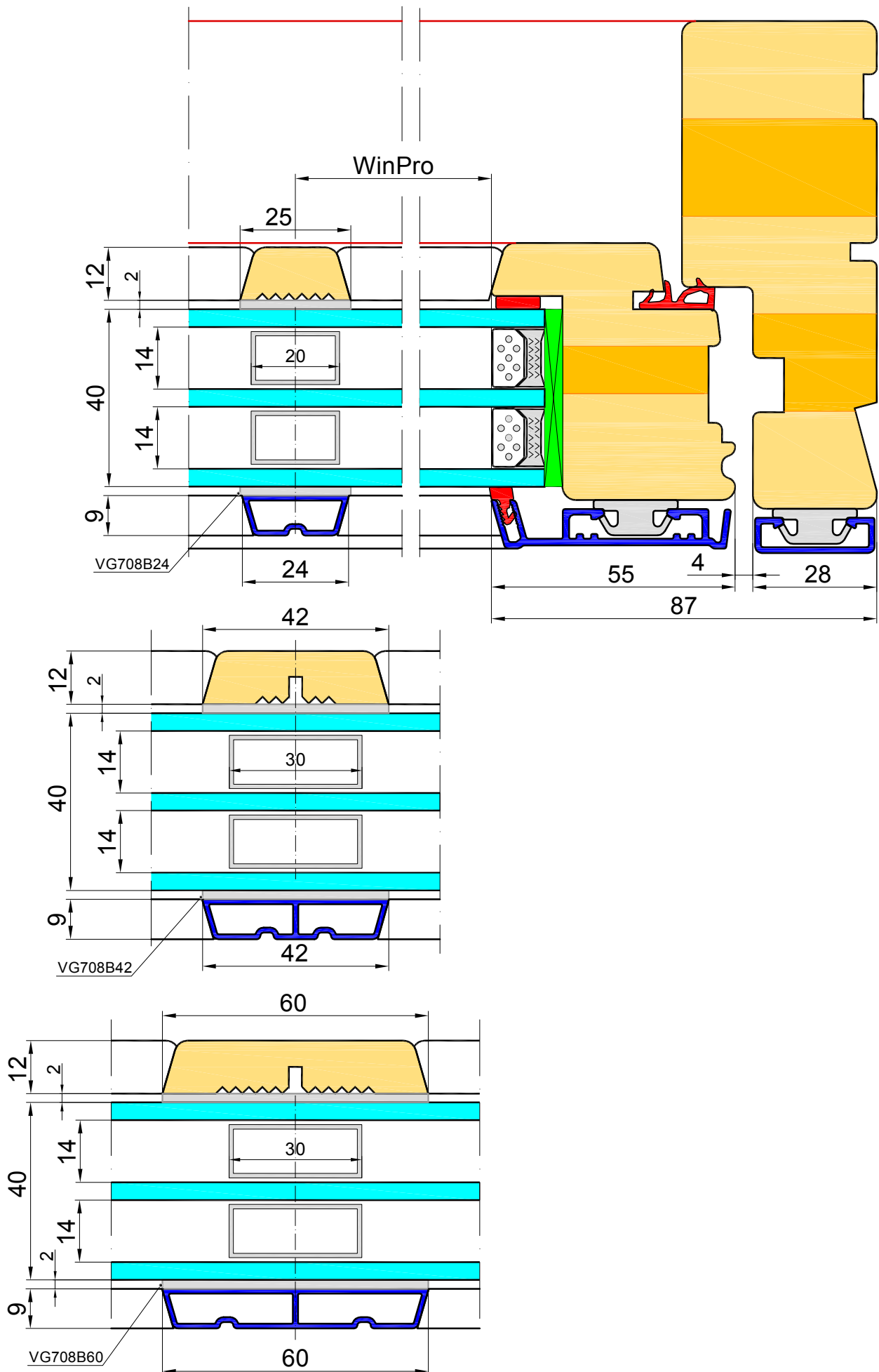

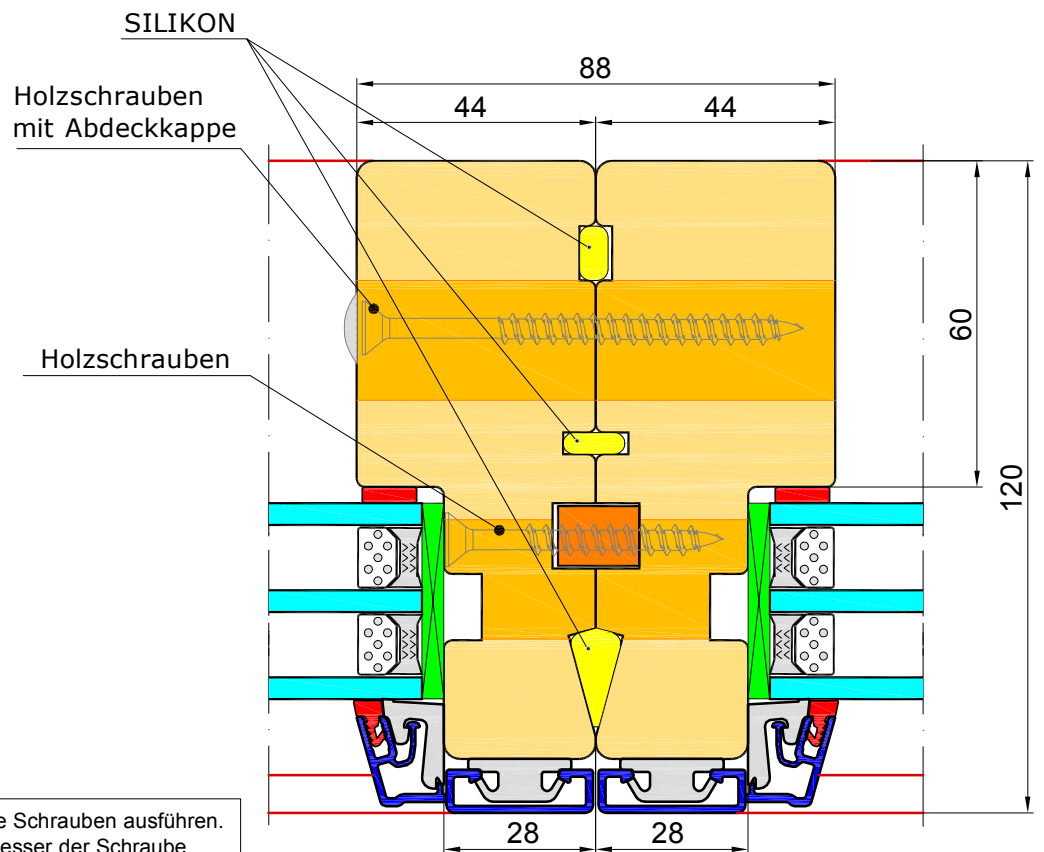
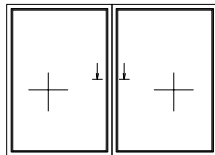
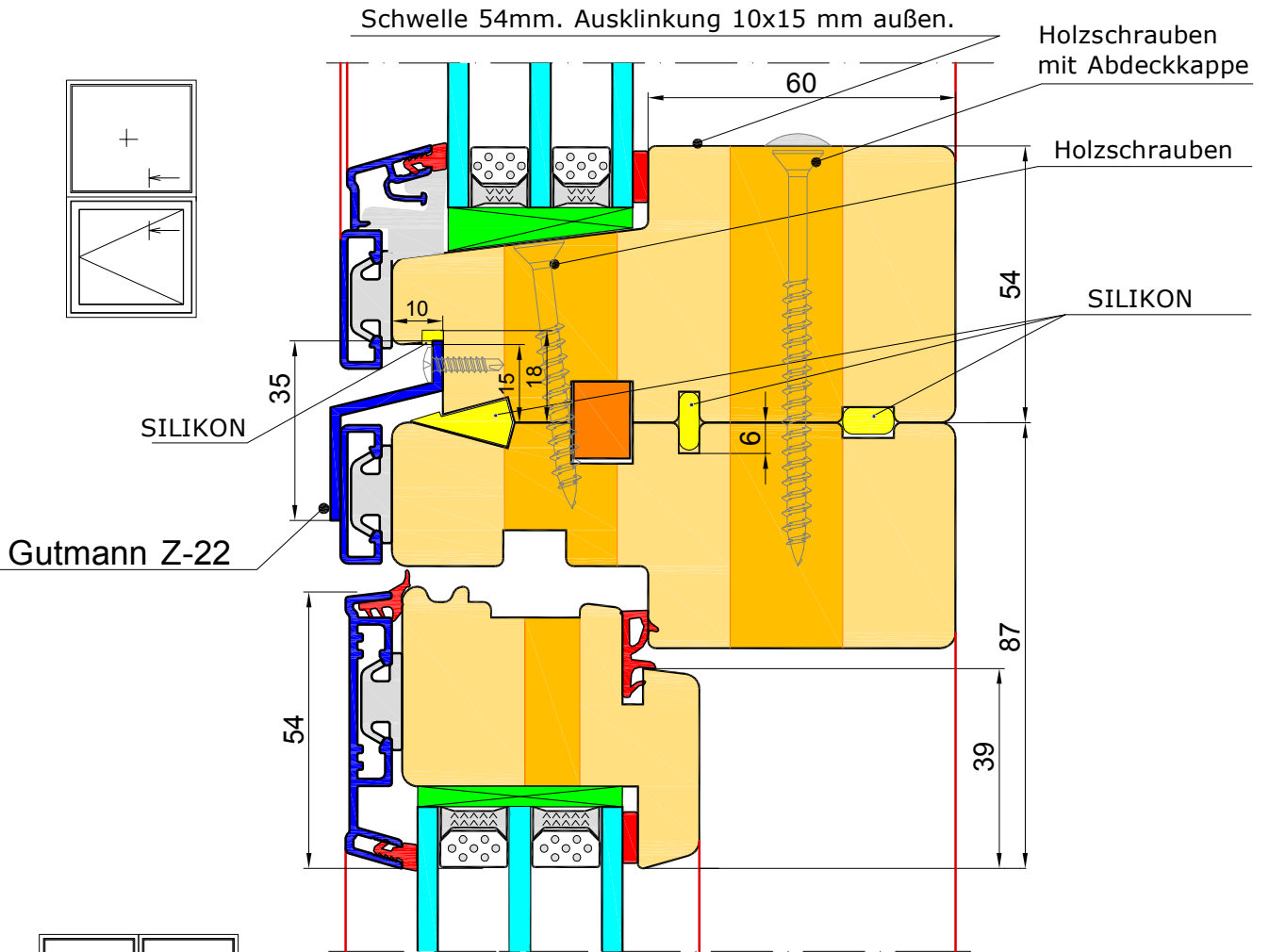

Achtung: Bitte Bohrlöcher für die Schrauben ausführen.
Bohrergröße = Mittlerer Durchmesser der Schraube

Stockverbreiterung 25mm

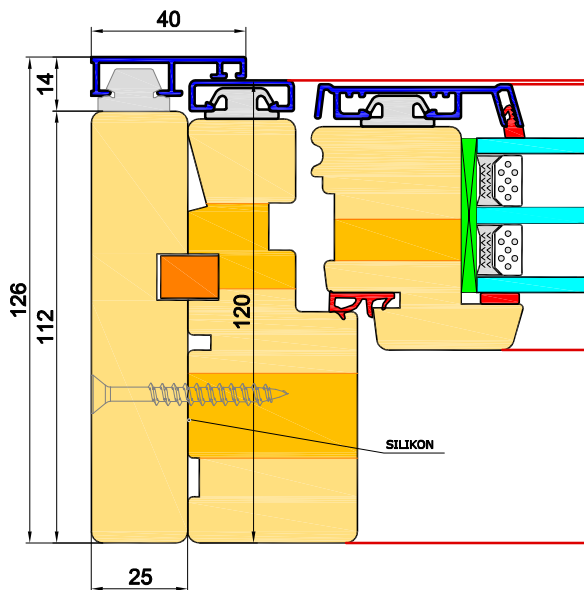

Stockverbreiterung 30mm

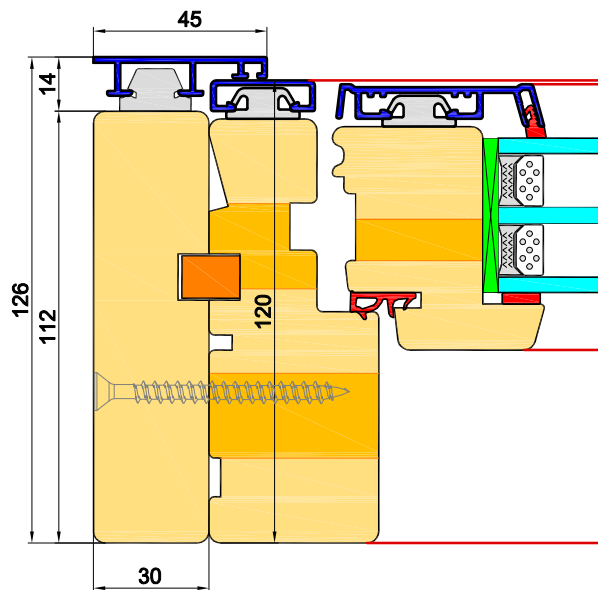

Stockverbreiterung 40mm

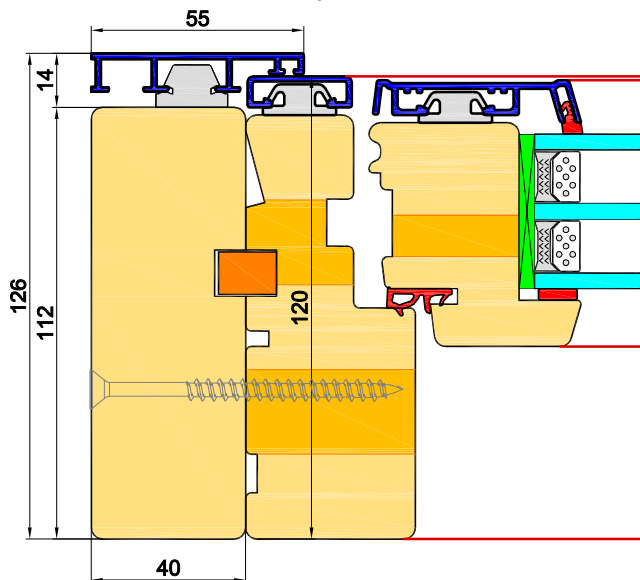

Stockverbreiterung 70mm

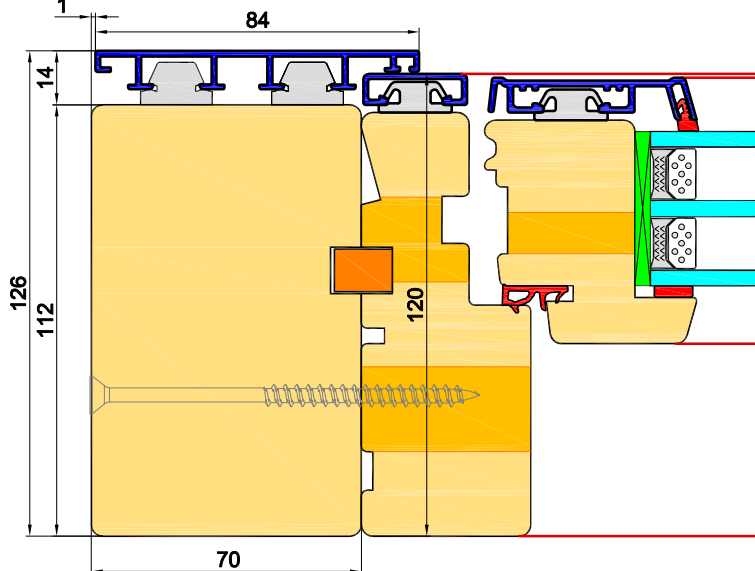

Achtung: Bitte Bohrlöcher für die Schrauben ausführen.
Bohrergröße = Mittlerer Durchmesser der Schraube

