

PURO - Fenster und Balkontüren.

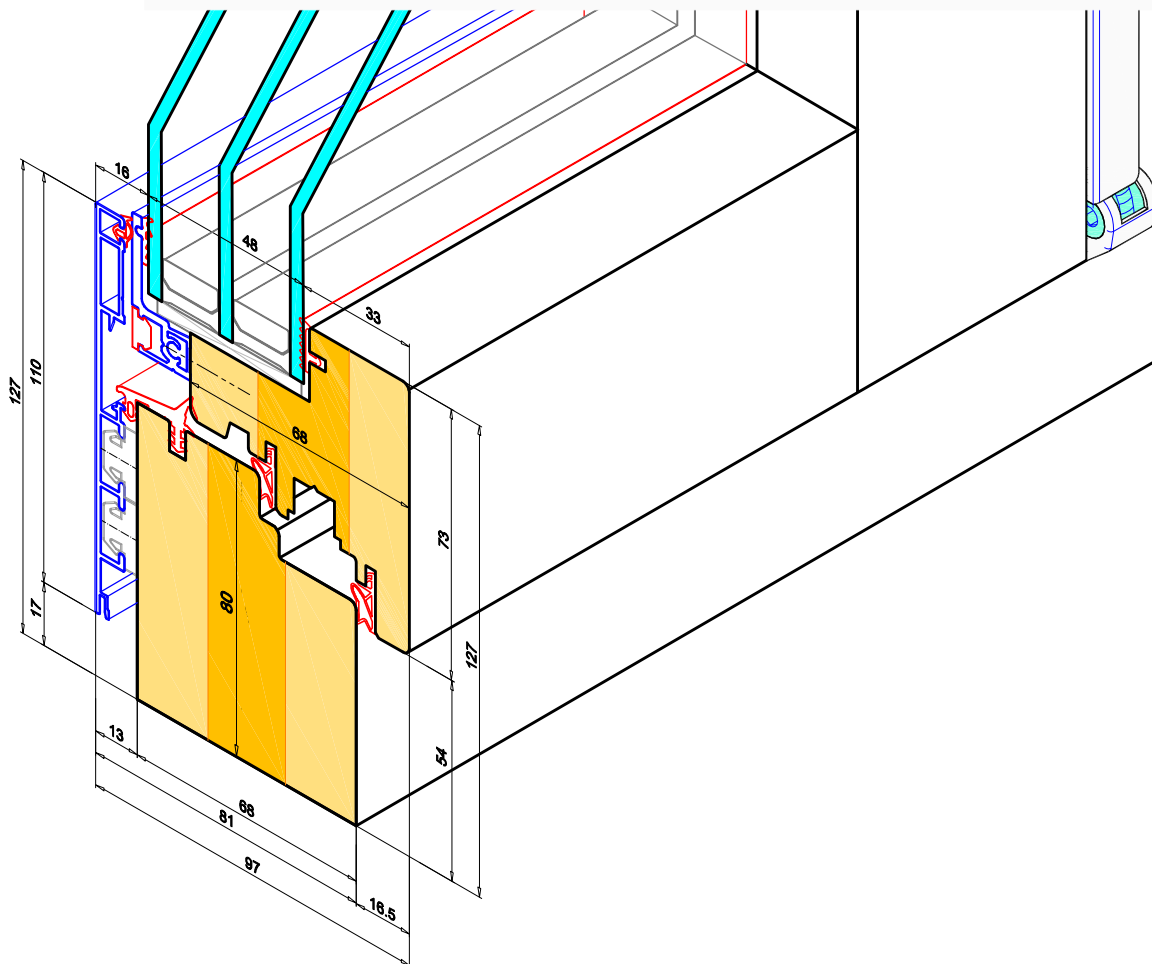

<i>Feature</i>		<i>Beschreibung</i>
1	Konstruktion	PURO
2	MATERIAL	- Lasierte Kiefer (durchgehend), - Eiche,
3	Beschlagsoptionen	- kipp, dreh, dreh-kipp, kipp-dreh, - Stulp (Kämpfer) mit Espagnolette, - Oberlichten-Schließer (kipp) mit Hebel (Hau-Tau), - Sicherheitsbeschläge RC1 , RC2, - Schiebe-kipp Beschlag, - Balkontür mit niedriger Aluschwelle, - Verdecktliegende Beschläge, - Umkehrfunktion des Griffes (Kipp vor Drehfunktion),
4	Mögliche Formen	-rechtwinkelig,
5	Maß	Breite des Flügels: 346 - 1547mm Höhe des Flügels: max 2600mm. Proportion Breite/Höhe des Flügels - max 1,5. maximales Gewicht des Flügels 130kg - (kipp, dreh-kipp). maximales Gewicht des Flügels 50kg - (dreh). maximales Gewicht 80kg - (Dreieck-, Rund-, Bogen-Element) Gewicht des Glases 1m ² mit einer Stärke von 1mm = 2,5 kg
6	Verglassung	Dicke des Glaspaketes 47.5mm - 48.8mm
7	Endgültige Beschichtung (Finish)	Lackierung mit Deckfarben oder mit Transparentfarben
8	Farben	- Deckfarbe RAL 9016 (weiß) - Lasuren: Kiefer TM367, Afromosie TM4239, Mahagoni TM1530, Palisander TM1705, Teak TM1703, Zypresse TM5207, Wenge TM9012, Nuss TM1515, Graphit TM1504, Natur lasur - andere Optionen entsprechend RAL-Palette,
9	Zusätzliche Optionen	- Kopplung - 90° Eck-Kopplung, - 135° Eck-Kopplung, - Schwellen: a) Fensterbankanschluss außen + innen 11x 30mm, b) Fensterbankanschluss innen 11x30mm, c) Fensterbankanschluss außen 12x30 mm, d) Fensterbankanschluss außen + innen 11x14mm , e) Fensterbankanschluss außen 12x30 mm + Fräsung 10x10mm innen, f) ohne Fräsung,

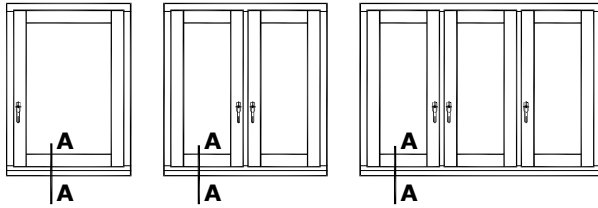

A-A

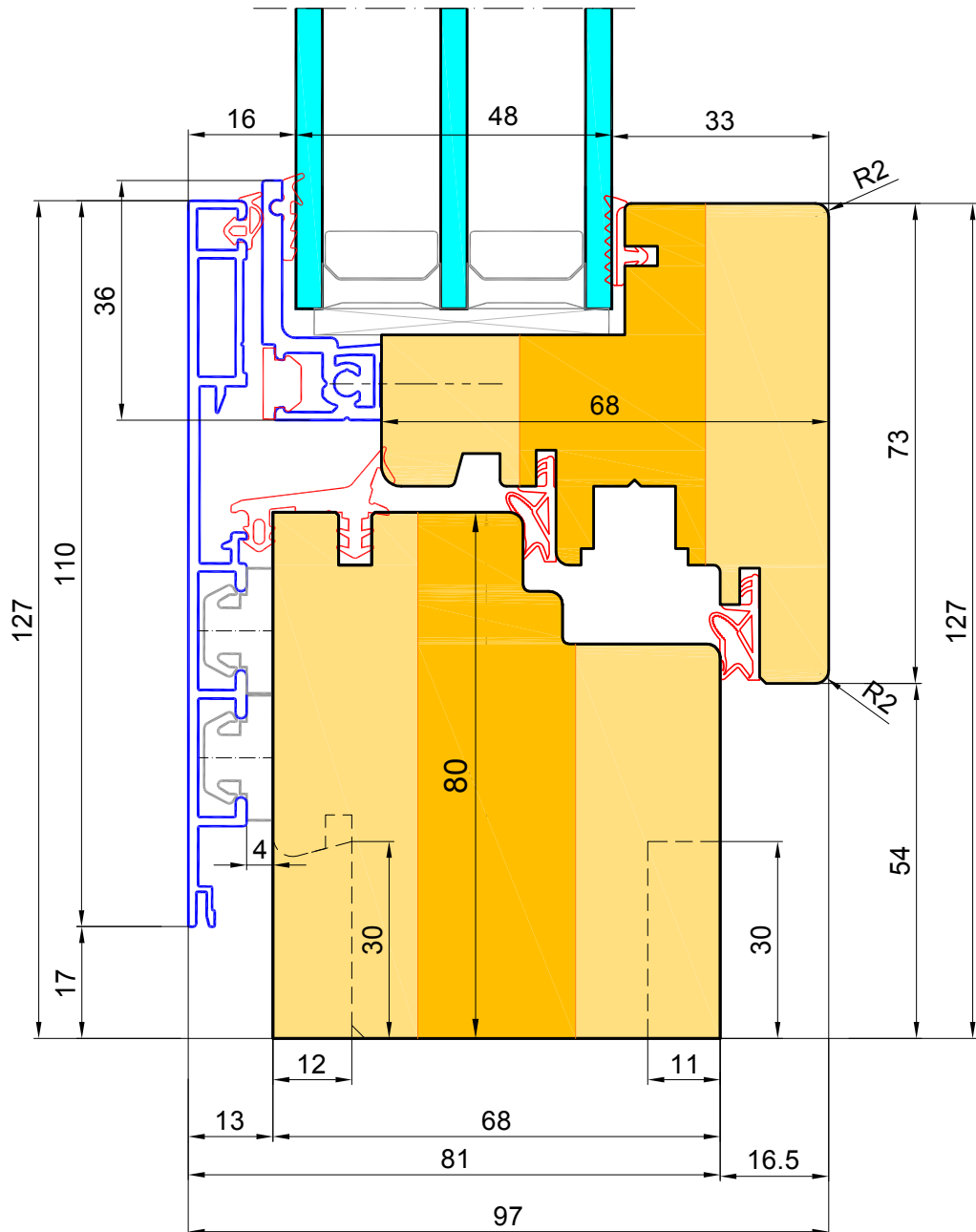

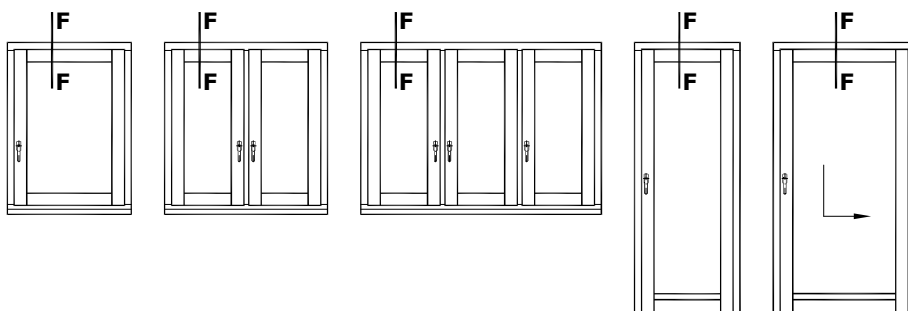

F-F

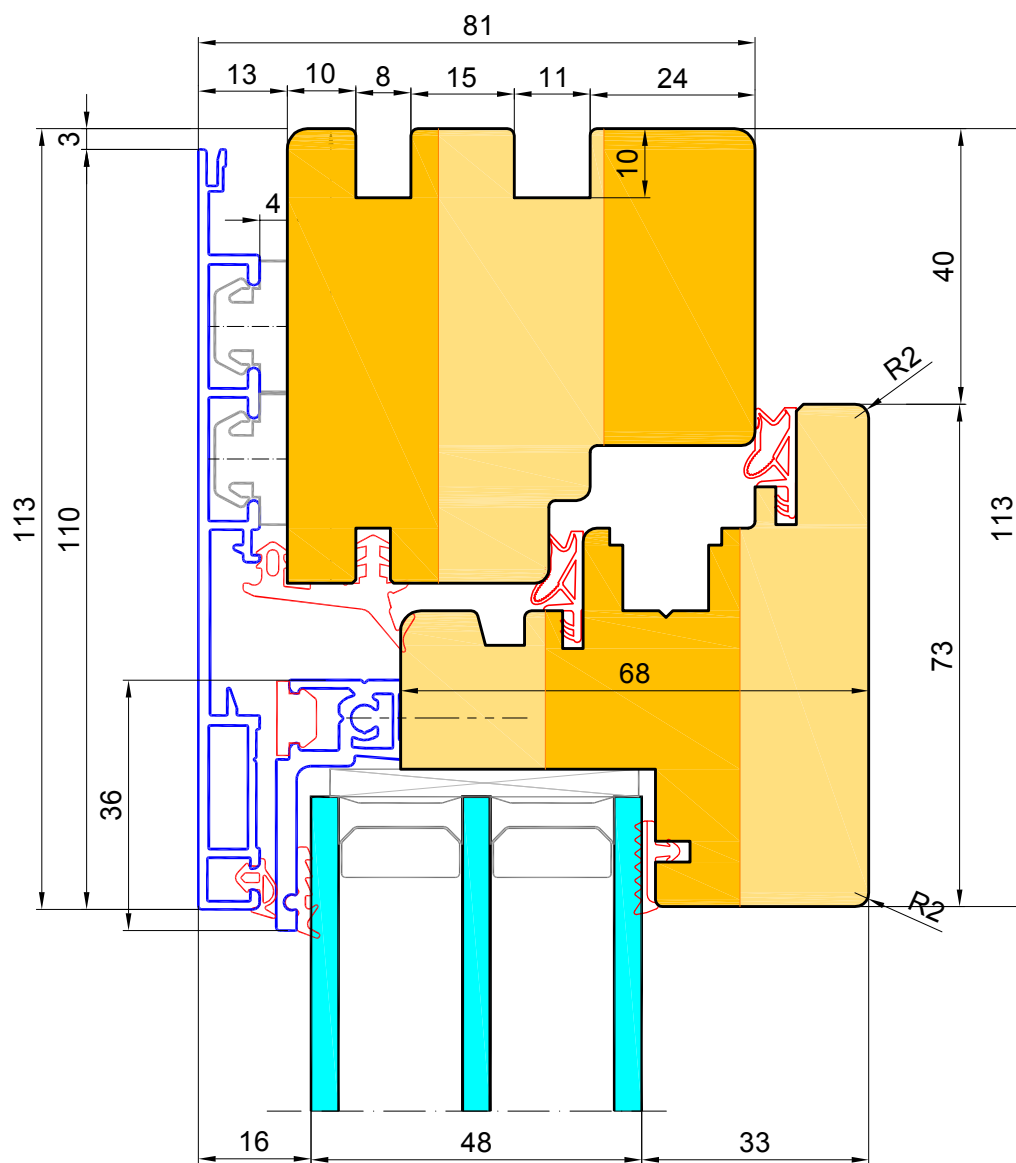

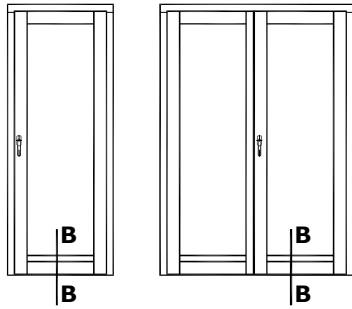

B-B

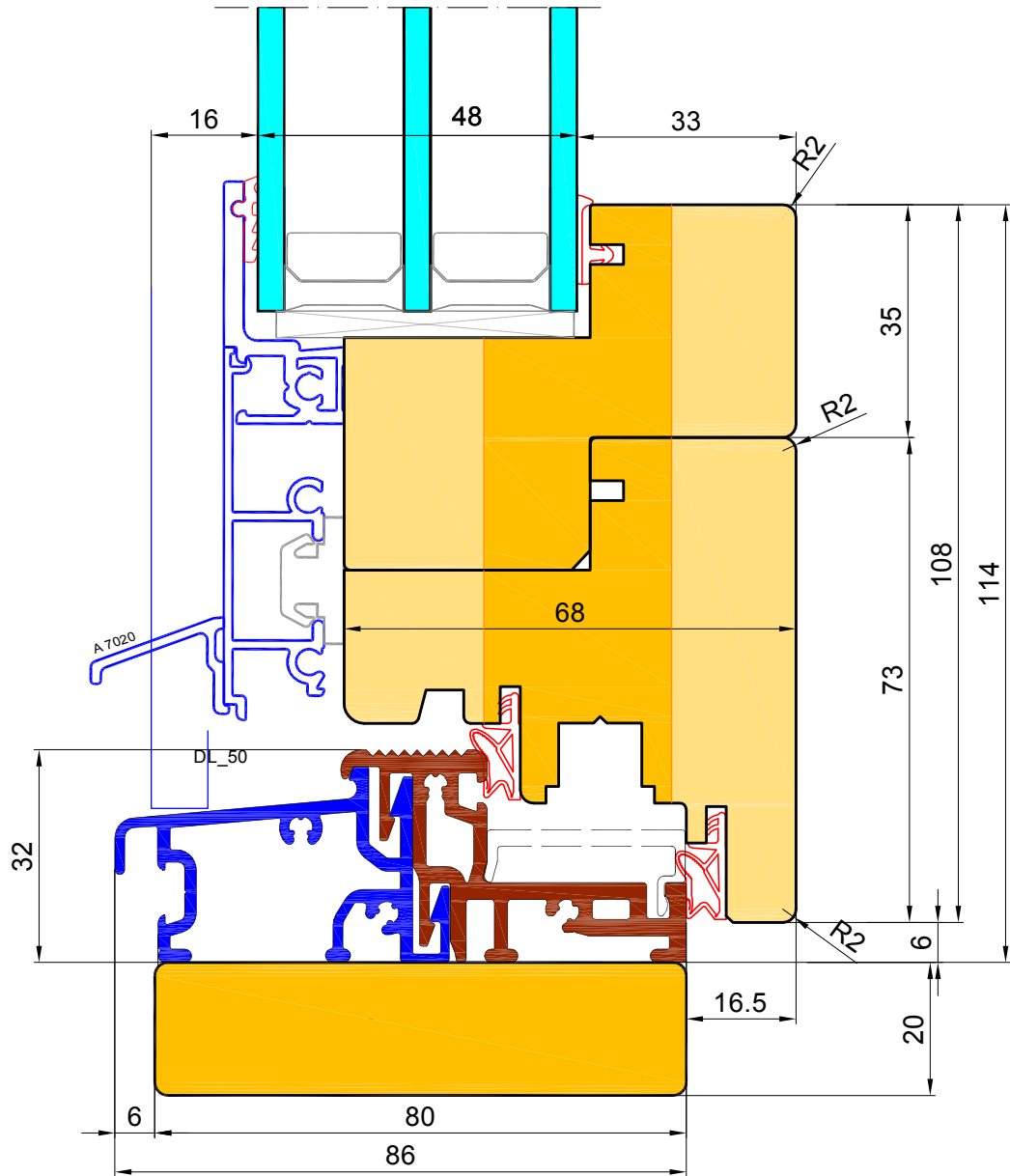

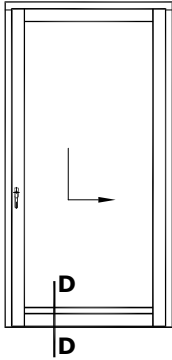

D-D

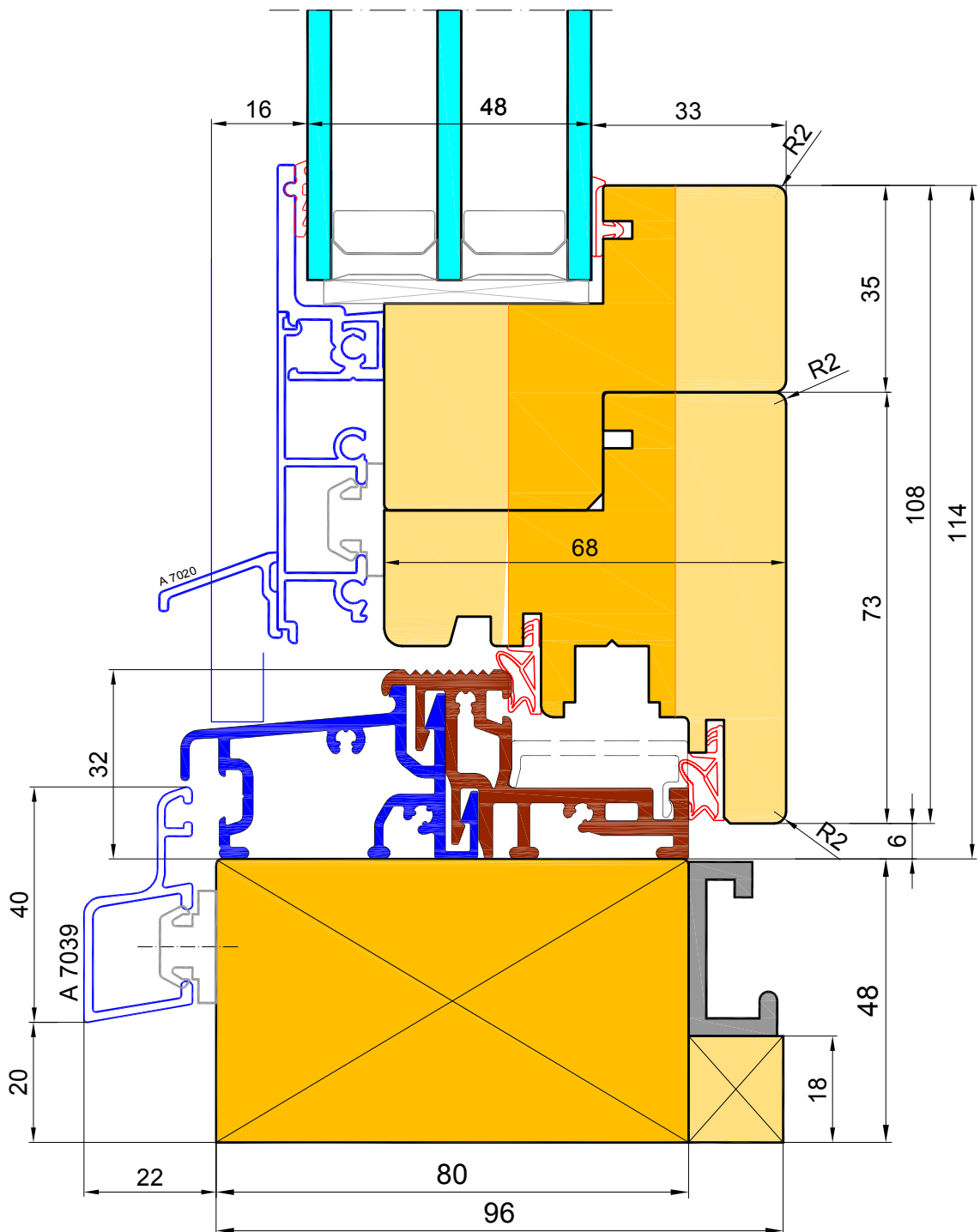

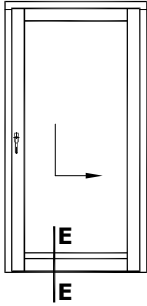

E-E

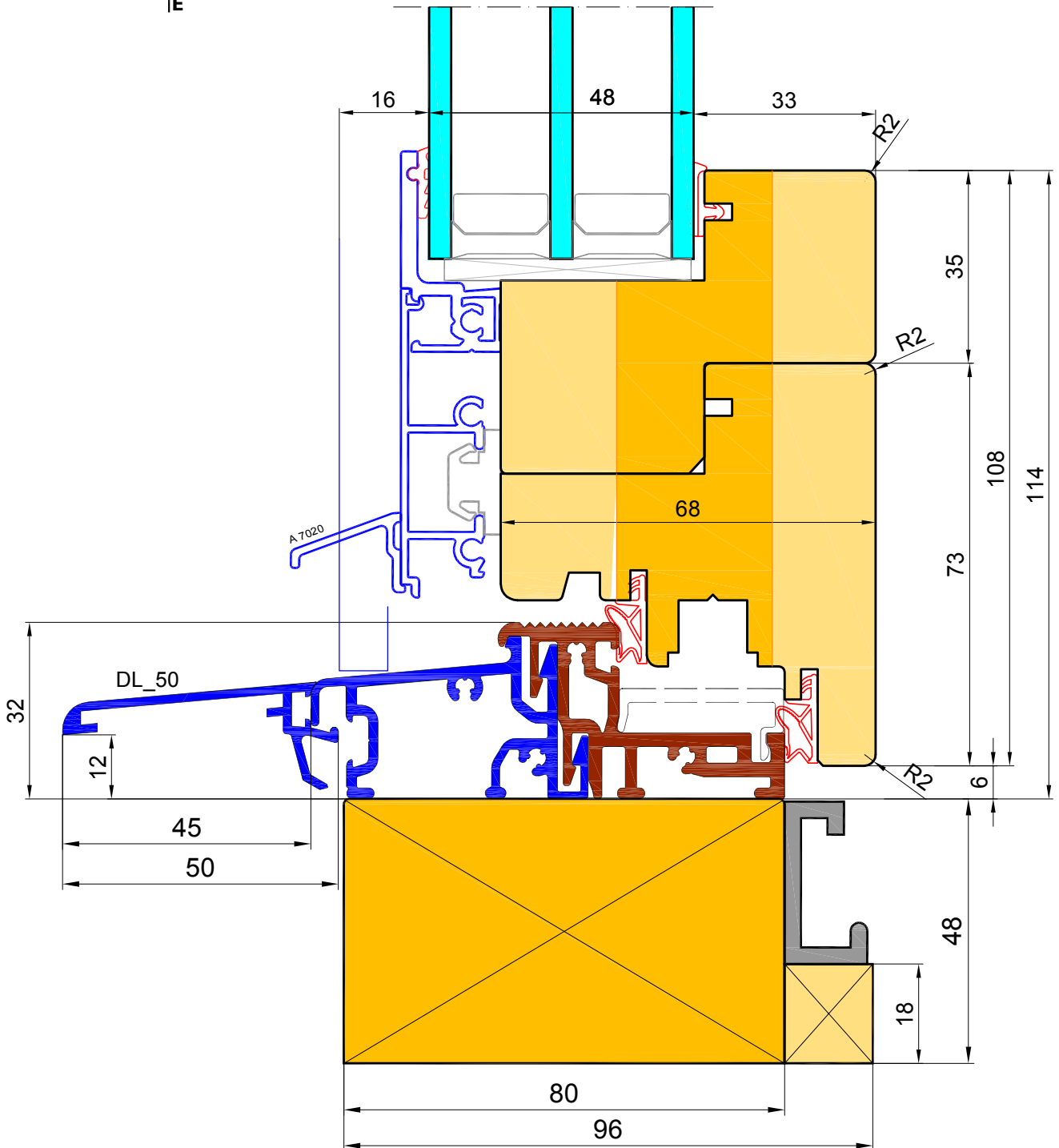

G-G

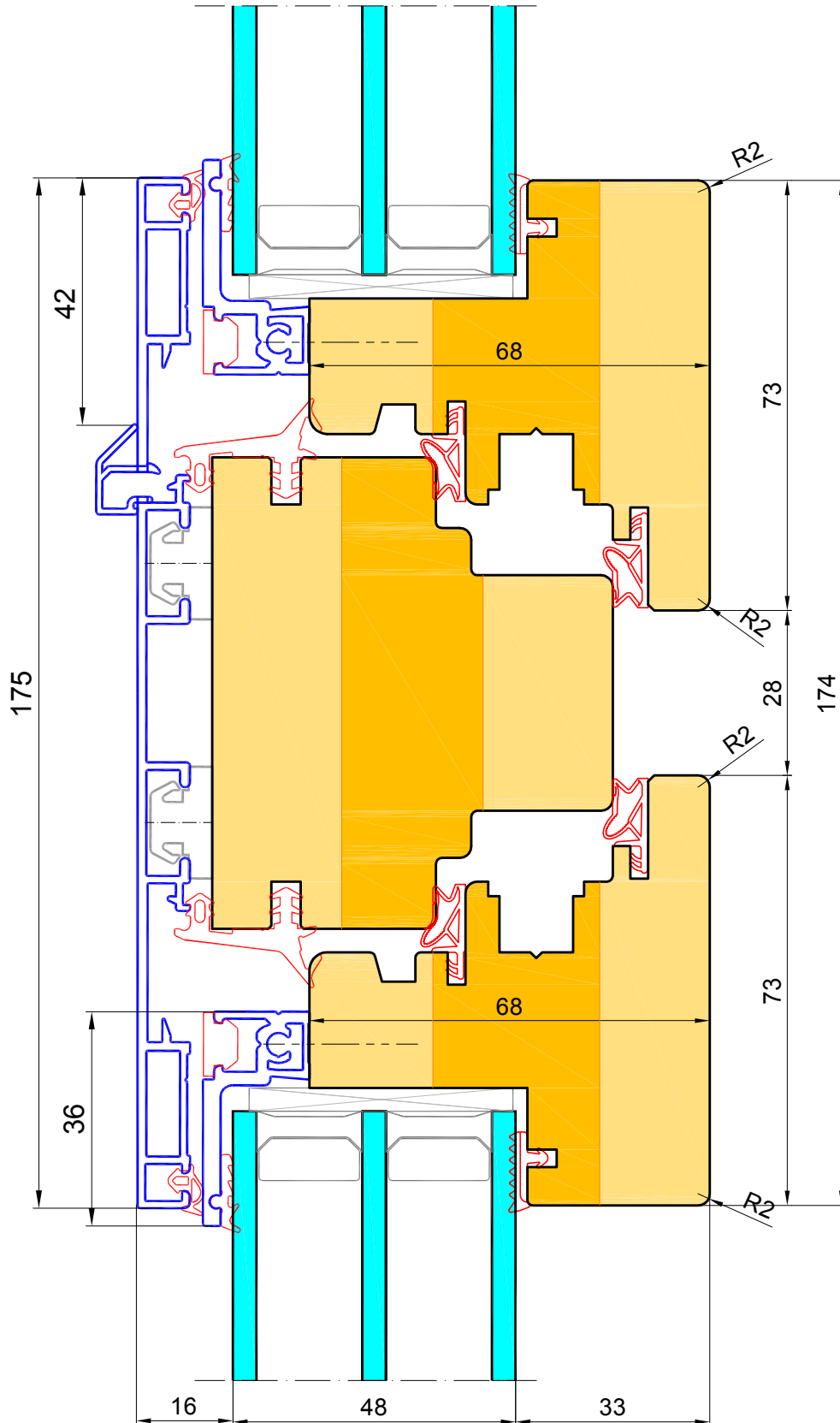
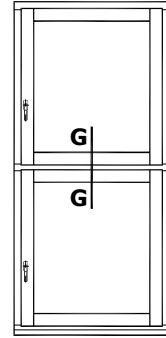

I-I

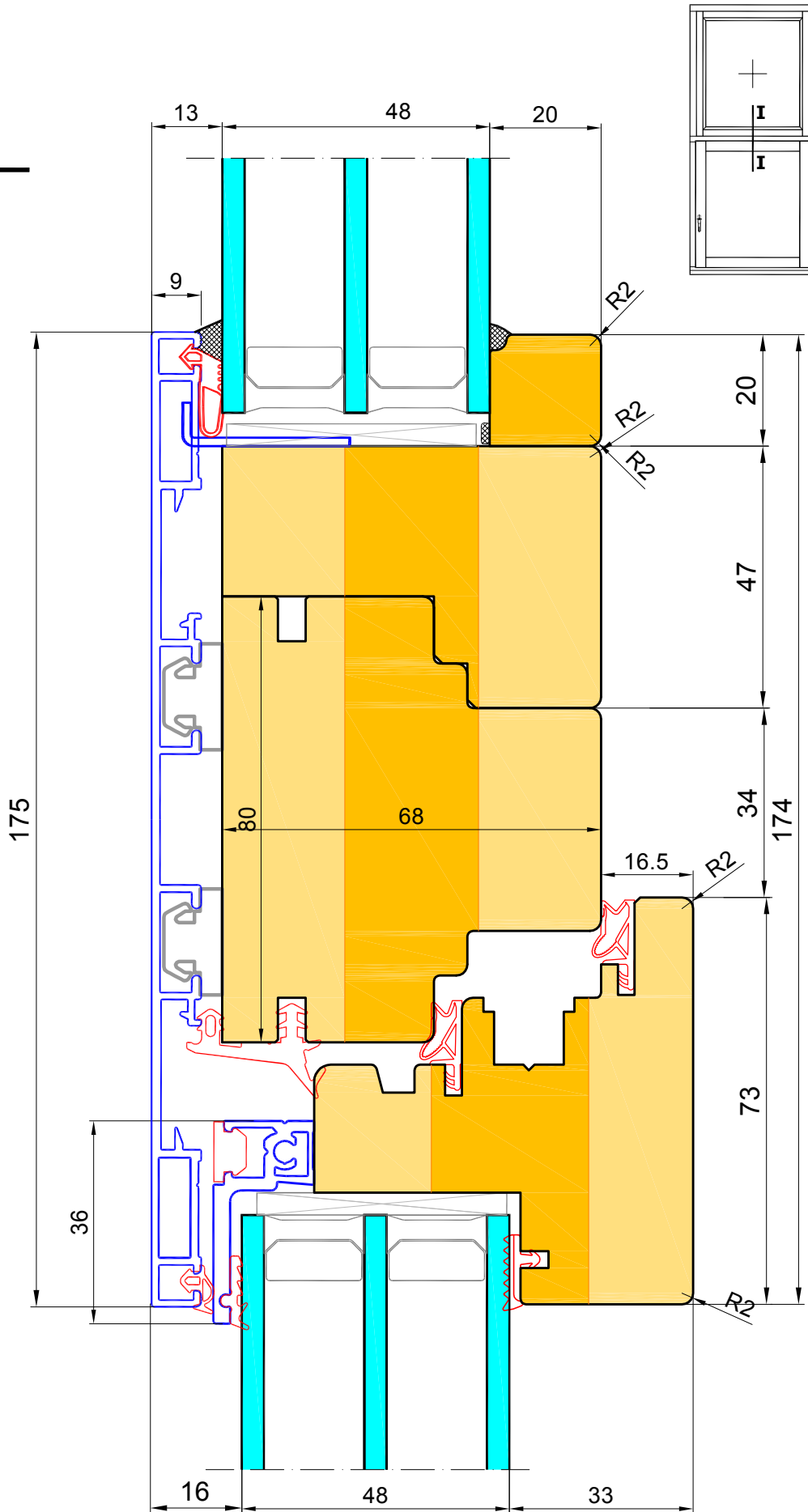

J-J

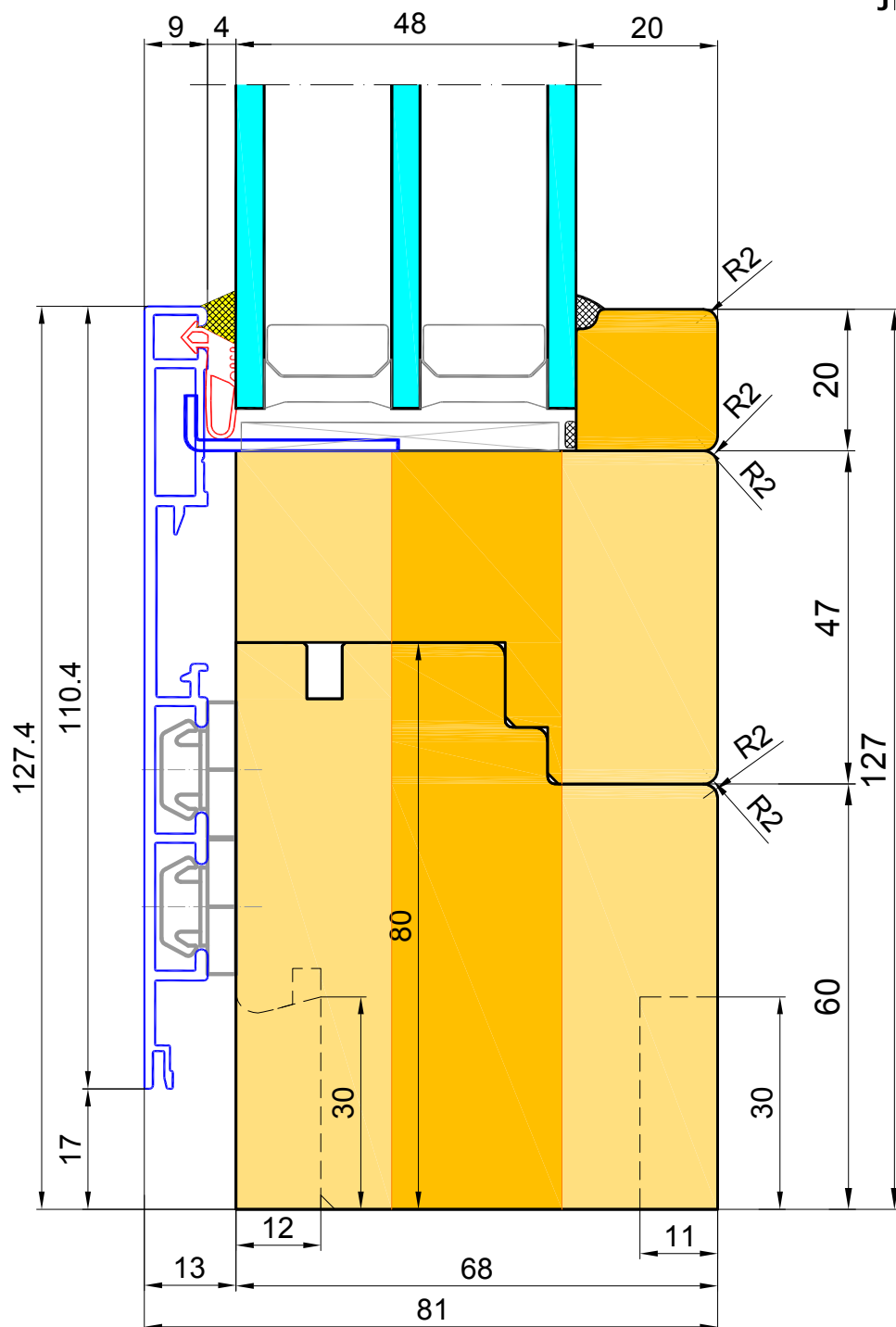
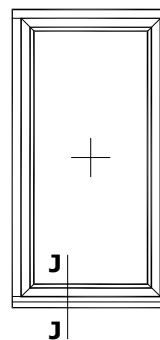

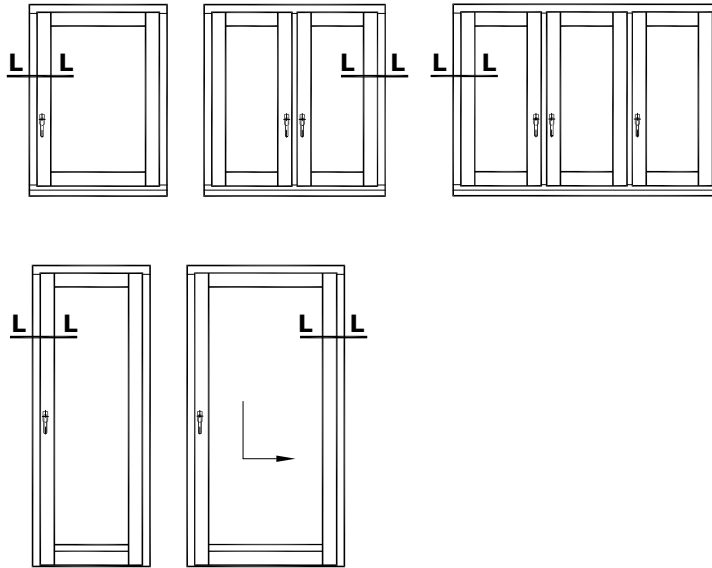

L-L

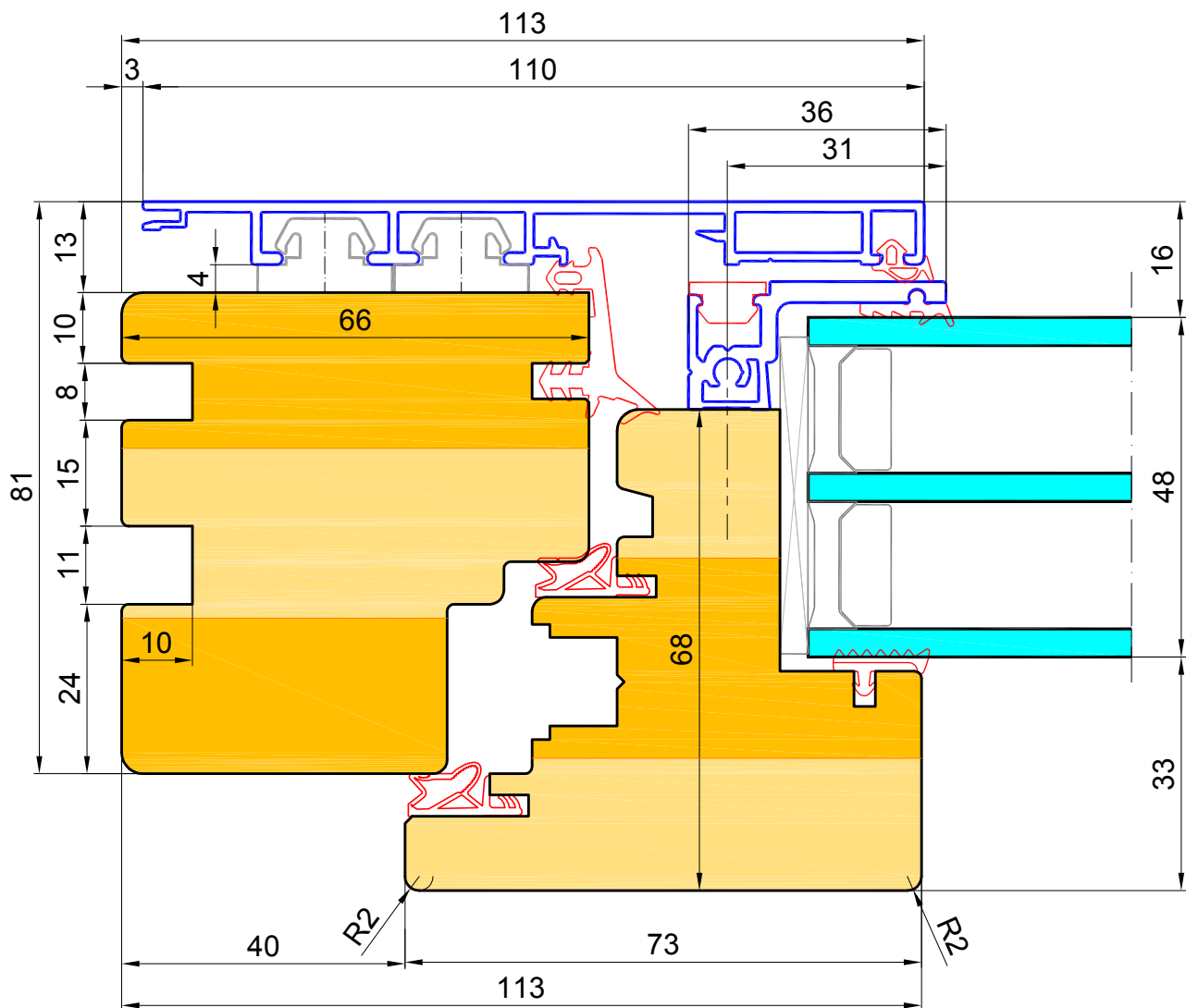

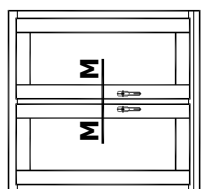
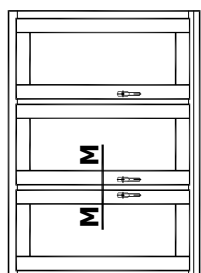

M-M

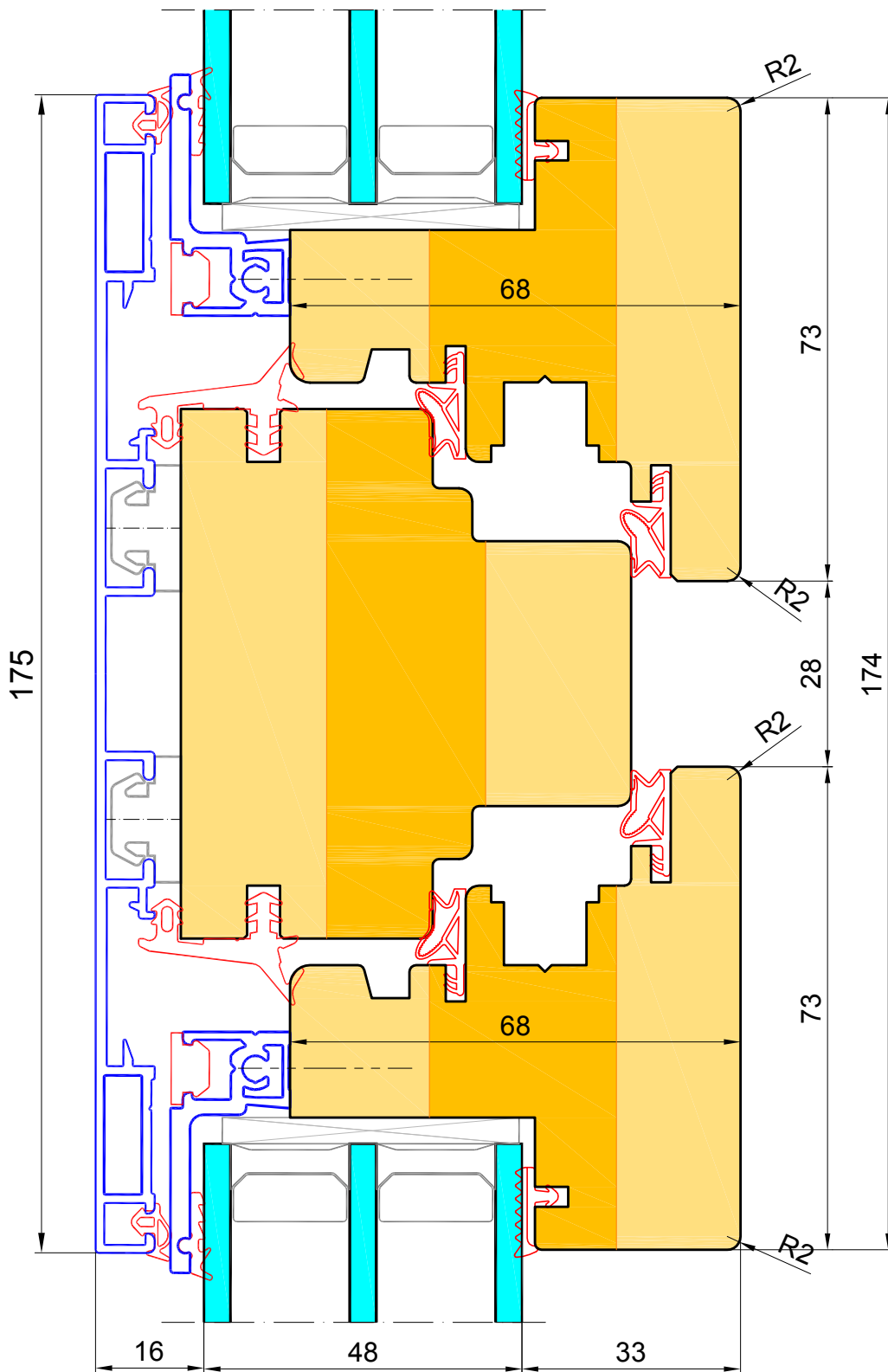

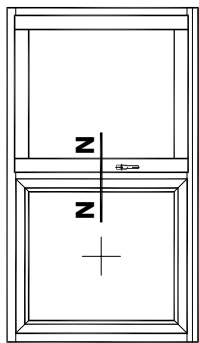

N-N

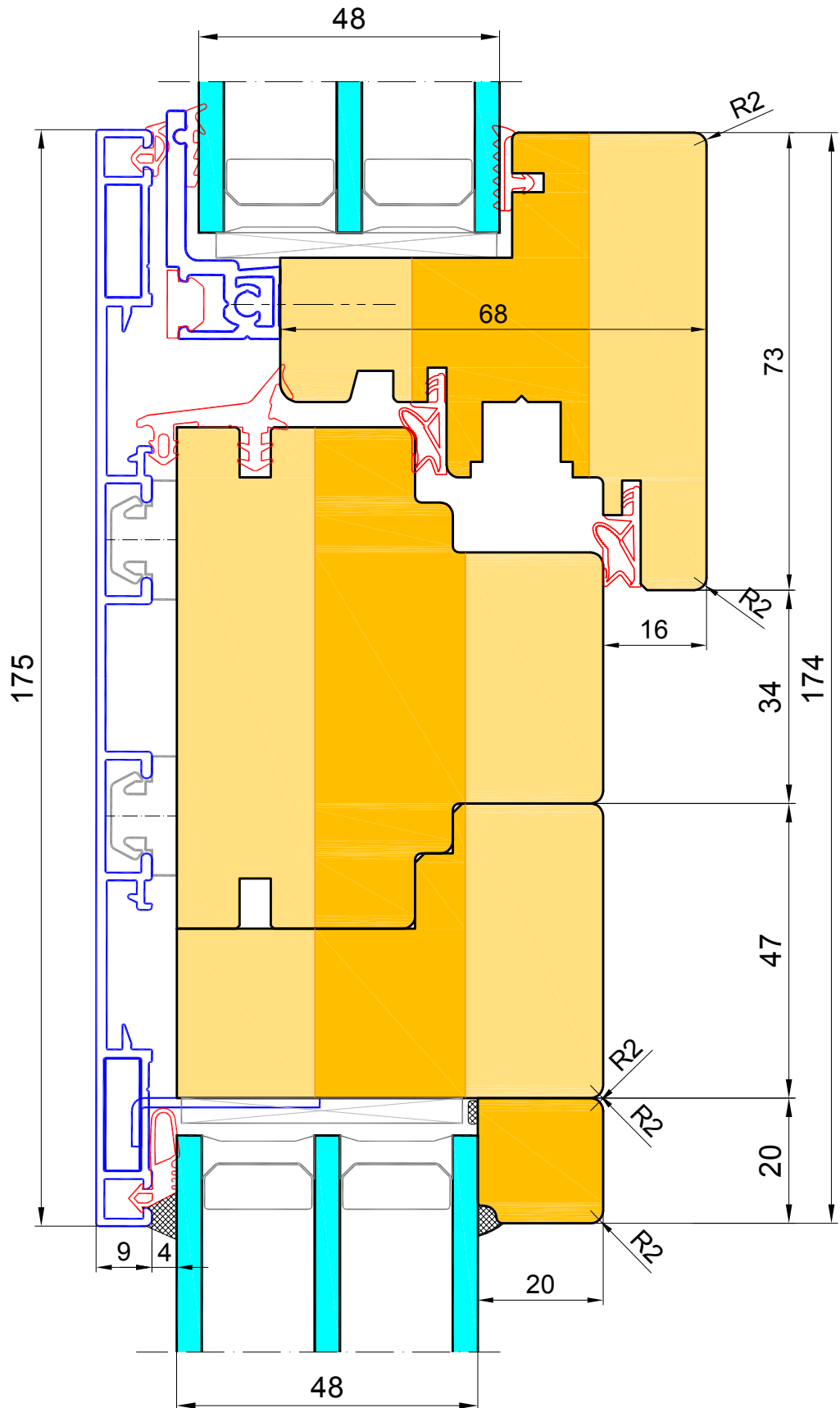

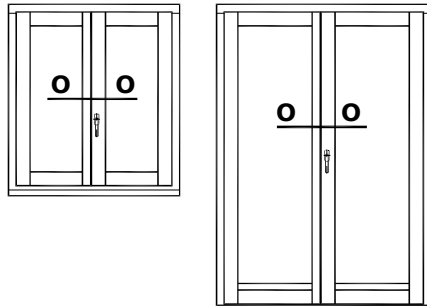

N-N

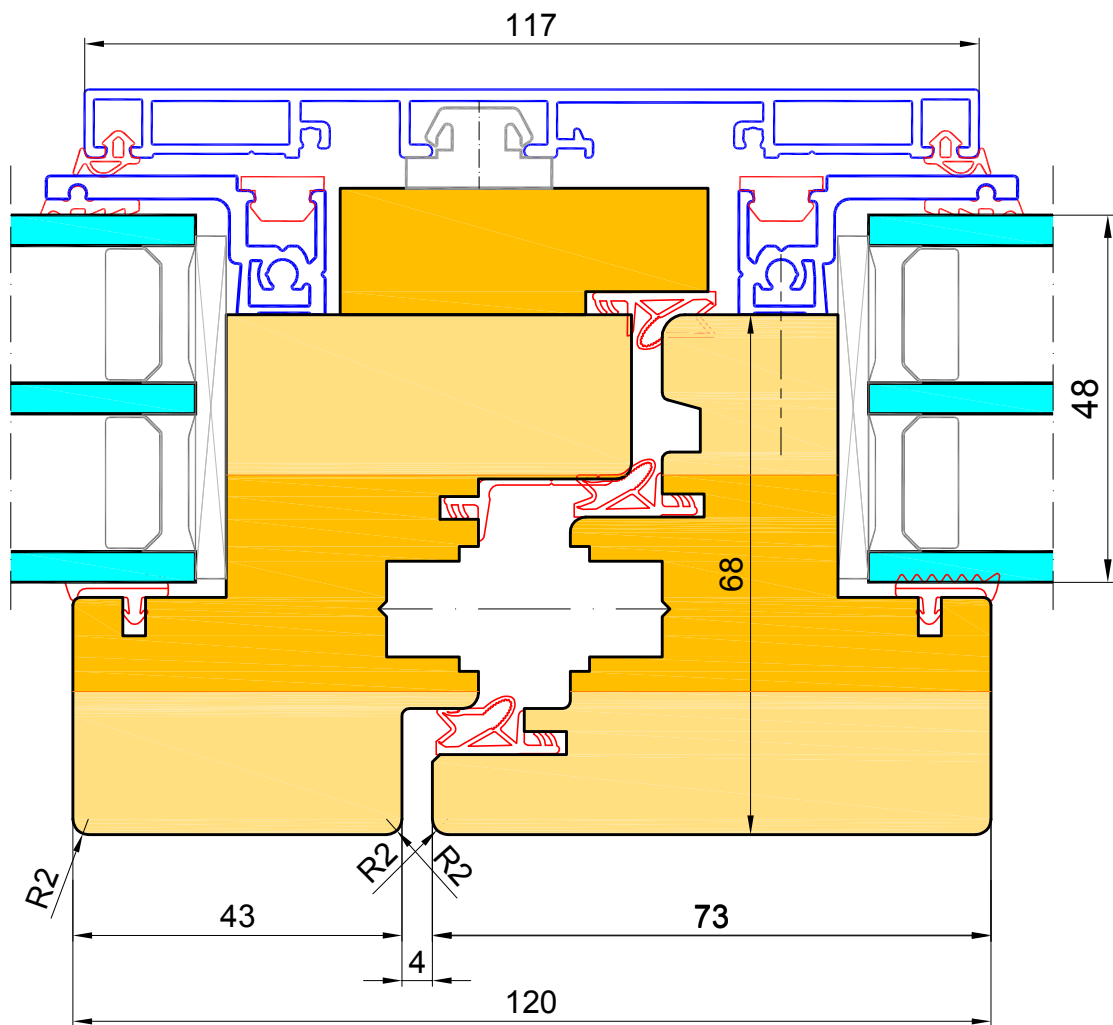

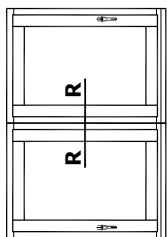

R-R

